

Numerical Line Differential Protection SIPROTEC 7SD600 V3.1

System Manual

Order no. E50417-G1176-C069-A4



Figure 1 The numerical line differential protection 7SD600

Trademarks

All brand or product names used may be trademarks or registered trademarks of their respective holder.

Disclaimer

We have checked the contents of this publication and every effort has been made to ensure that the descriptions of both hardware and software are as accurate as possible. However, deviations from the description cannot be completely ruled out, so that no liability can be accepted for any errors or omissions contained in the information given. The data in this manual are checked regularly and the necessary corrections are included in subsequent editions. We are grateful for any improvements that you care to suggest.

Copyright

No part of this document may be reproduced, transmitted or disclosed in any form or by any means without express permission. Any duplication is a violation of the law and subject to criminal and civil penalties. All rights reserved in the event of a patent award or utility model registration.

Warranty

The contents of this manual are not part of, nor do they affect, any existing contract, commitment or legal relationship. All obligations to which Siemens is subject are detailed in the relevant sales contract which also contains the full warranty specifications. This system manual does not limit or extend the terms of warranty as specified in the sales contract.

Technical specifications may be altered without prior notice.

The following does not represent a complete list of all the safety measures required for the operation of the equipment (device, module) as certain operating conditions may necessitate further measures.



Warning

During the operation of electric equipment, certain parts of the equipment will always be subject to dangerous voltages. Improper use can cause serious personal injury or material damage.

- Before setting up any electrical connections, the PE terminal of the equipment must be correctly earthed.
- All parts of the circuit linked to the power supply may be subject to dangerous voltages.
- Equipment (capacitor storage) can still be subject to dangerous voltages even after the supply voltage has been disconnected.
- Open operation of current transformer circuits is not permitted.
- The threshold values specified in this manual, i.e. operating instructions, must not be exceeded; this also applies to testing and commissioning.
- Only competent persons are permitted to operate this equipment. In order to ensure the trouble-free and safe operation of this equipment, it is essential that it is properly transported, as well as correctly stored, assembled, operated and maintained.

These instructions cannot provide detailed information on all product types or cover every conceivable method of assembly, operation or maintenance.

If you require any further information, or if you experience any problems not dealt with in detail in the system manual, please contact your local Siemens dealer for assistance.

Competent persons are persons who are familiar with the installation, assembly, commissioning and operation of the product and who have the relevant qualifications, such as, e.g.

- Training or instruction, i.e. authorization to switch electric circuits and devices/systems on and off, as well as disconnect, earth and mark said equipment in accordance with standard safety requirements.
- Training or instruction in the maintenance and implementation of appropriate safety equipment in accordance with standard safety requirements.
- First Aid training.

CE Declaration of Conformity

The product is herewith confirmed to comply with the requirements set out in the Council Directive on the Approximation of the Laws of the Member States relating to Electromagnetic Compatibility (89/336/EEC) and the use of electrical equipment within certain voltage limits (the Low Voltage Directive 73/23/EEC).

This conformity has been tested by SIEMENS AG in accordance with article 10 of the Directive which complies with the basic specifications of EN 50081 and EN 50082 for the EMC Directive and the basic specifications of EN 60255-6 for the Low Voltage Directive.

The device has been developed and manufactured for industrial use to EMC standards.

The evaluation has been carried out in accordance with the international standards of the IEC 60255 series and the national standards DIN 57 435 / Part 303 (corresponds to VDE 0435 / Part 303).



		page
1	Introduction	1 - 1
1.1	Application	1 - 1
1.2	Features	1 - 2
1.3	Functional scope	1 - 3
2	Design	2 - 1
2.1	Models	2 - 1
2.2	Dimensions	2 - 2
2.2.1	Summation transformer 4AM4930	2 - 5
2.3	Order data	2 - 6
3	Technical Data	3 - 1
3.1	Standards and Directives	3 - 3
3.2	Operating conditions	3 - 5
3.3	Line differential protection	3 - 6
3.4	Transfer trip function	3 - 8
3.5	Lockout function	3 - 8
3.6	Emergency overcurrent protection	3 - 8
3.7	Additional functions	3 - 8
3.8	Summation transformer 4AM4930	3 - 9
4	Method of Operation	4 - 1
4.1	Overall function	4 - 1
4.2	Summation transformer 4AM4930	4 - 3
4.3	Line differential protection	4 - 5
4.3.1	Principle of differential protection	4 - 5
4.3.2	Stabilized differential protection	4 - 5
4.3.3	Formation of measured values for line differential protection with two pilot wires	4 - 6
4.3.4	Measured value processing	4 - 7
4.3.5	Additional stabilization in the case of current transformer saturation	4 - 8
4.3.6	Local current threshold	4 - 8
4.3.7	In rush stabilization with second harmonic	4 - 8
4.3.8	Starting, blocking and tripping logic	4 - 9
4.4	Pilot wire monitoring (optional), transfer tripping, intertripping	4 - 11
4.4.1	Pilot wire monitoring	4 - 11

C

Contents

	page
4.4.2	Intertrip function 4 - 12
4.4.3	Transfer trip function 4 - 12
4.5	Emergency overcurrent function 4 - 15
4.6	Additional functions 4 - 16
4.6.1	Processing of events 4 - 16
4.6.1.1	Display and binary outputs (signal relay) 4 - 16
4.6.1.2	Information via display panel or PC 4 - 16
4.6.2	Disturbance recording 4 - 17
4.6.3	Measurement of operational values 4 - 17
4.6.4	State interrogation 4 - 17
4.6.5	Monitoring functions 4 - 17
4.6.5.1	Hardware monitoring 4 - 17
4.6.5.2	Software monitoring 4 - 18
5	Preparation Instructions 5 - 1
5.1	Packing and unpacking the device 5 - 1
5.2	Preparing for operation 5 - 2
5.2.1	Assembly and connection 5 - 2
5.2.1.1	Models 7SD600★-★B★★★ and ★D★★★ for panel surface mounting 5 - 2
5.2.1.2	Model 7SD600★-★E★★★ for panel flush mounting or cubicle mounting 5 - 2
5.2.2	Checking the specified ratings 5 - 2
5.2.2.1	Auxiliary supply 5 - 3
5.2.2.2	Control voltage for binary input 5 - 3
5.2.3	Checking the connections 5 - 6
5.2.4	Connection circuits 5 - 6
5.2.4.1	Standard connection L1-L3-E 5 - 6
5.2.4.2	Connection for reduced earth-fault sensitivity L1-L2-L3 5 - 7
5.2.4.3	Connection for increased earth-fault sensitivity L1-L3-E 5 - 7
5.2.4.4	Different primary nominal currents 5 - 8
5.2.4.5	Two-phase connection 5 - 8
5.2.4.6	Connection of the pilot wires 5 - 9
5.2.5	Demands on the current transformer 5 - 9
5.2.6	Demands on the pilot wires 5 - 9
5.3	Setting the operator and memory functions 5 - 11
5.3.1	Operating conditions and general information 5 - 11

	page
5.3.2	Settings for integrated operation - block 71 5 - 14
5.3.3	Settings for the serial interface - block 72 5 - 15
5.3.4	Settings for fault detection - block 74 5 - 17
5.4	Configuring the protective functions 5 - 18
5.4.1	Introduction 5 - 18
5.4.2	Configuring the functional scope of the device - block 00 5 - 19
5.5	Marshalling of binary inputs, binary outputs and displays 5 - 20
5.5.1	Introduction 5 - 20
5.5.2	Marshalling of the binary inputs - block 61 5 - 22
5.5.3	Marshalling of signal relay - block 62 5 - 24
5.5.4	Marshalling of the LEDs - block 63 5 - 26
5.5.5	Marshalling of the command relays - block 64 5 - 28
6	Operating Instructions 6 - 1
6.1	Safety measures 6 - 1
6.2	Operating the device 6 - 1
6.2.1	Membrane keypad/Display panel 6 - 1
6.2.2	Operation with a PC 6 - 2
6.2.3	Prerequisites for operation 6 - 2
6.2.4	Front view of the device 6 - 3
6.3	Setting of function parameters 6 - 4
6.3.1	Introduction 6 - 4
6.3.1.1	Procedure for parameterization 6 - 4
6.3.1.2	Setting date and time 6 - 6
6.3.2	Initial display 6 - 7
6.3.3	System and station data - Block 01 6 - 8
6.3.4	Settings for the line differential protection 6 - 10
6.3.5	Settings for the pilot wire monitoring 6 - 14
6.3.6	Settings for the transfer tripping 6 - 15
6.3.7	Settings for tripping on receiving a remote command 6 - 16
6.3.8	Settings for the emergency overcurrent protection 6 - 17
6.4	Events (alarms) 6 - 18
6.4.1	Introduction 6 - 18
6.4.2	Operational annunciations/events - block 81 6 - 20
6.4.3	Fault events/annunciations - block 82 6 - 23

C Contents

	page
6.4.4	Reading out operational measured values - block 84 6 - 27
6.5	Operational control capabilities 6 - 28
6.5.1	Setting date and time 6 - 28
6.6	Testing and commissioning 6 - 30
6.6.1	General 6 - 30
6.6.2	Checking the line differential protection 6 - 31
6.7	Commissioning with primary measured signals 6 - 33
6.7.1	Checking the switching states of the binary inputs/outputs 6 - 33
6.7.2	Measuring and setting the pilot wire resistance 6 - 36
6.7.3	Checking the current transformer termination 6 - 38
6.7.4	Trip test with the circuit-breaker 6 - 40
6.7.5	Checking the transfer tripping (if available) 6 - 41
6.7.6	Checking the emergency overcurrent protection 6 - 41
6.7.7	Resetting the Lockout state 6 - 42
6.8	Putting the protection into service 6 - 43
7	Maintenance and Troubleshooting 7 - 1
7.1	Routine checks 7 - 1
7.2	Troubleshooting 7 - 2
7.2.1	Changing the fuse 7 - 2
8	Repairs 8 - 1
9	Storage 9 - 1
A.1	Overview diagram A - 1
A.2	Jumper position of R_x (Setting of the sensitivity of the pilot wire monitor) A - 2
A.3	Connection diagrams A - 3
A.4	Menu tree, Tables A - 8
A.5	Detailed calculation of the current transformer requirements A - 34
I	Index I - I

Figures

Figure 1.1	Line differential protection 7SD600 for operation with two pilot wires, block diagram	1 - 1
Figure 2.1	Dimensioned drawing of 7XP20 for panel surface mounting with terminals on the sides (dimensions in mm)	2 - 2
Figure 2.2	Dimensioned drawing of 7XP20 for panel surface mounting with terminals at top and bottom	2 - 3
Figure 2.3	Dimensioned drawing of 7XP20 for panel flush mounting or cubicle mounting (dimensions in mm)	2 - 4
Figure 2.4	Dimensioned drawing of the 4AM4930	2 - 5
Figure 3.1	Stabilization characteristic of the differential protection (shown for pre-settings)	3 - 7
Figure 3.2	Summation transformer 4AM4930	3 - 9
Figure 4.1	Hardware structure of the line differential protection 7SD600	4 - 1
Figure 4.2	Standard connection of summation transformer 4AM4930	4 - 3
Figure 4.3	Connection of summation transformer 4AM4930 to 2-current transformers in isolated-neutral systems or systems which are not effectively earthed.	4 - 4
Figure 4.4	Basic principle of differential protection	4 - 5
Figure 4.5	Differential protection with two pilot wires - flow chart	4 - 6
Figure 4.6	Characteristic of the differential protection	4 - 7
Figure 4.7	Simplified logic diagram of the differential protection	4 - 10
Figure 4.8	Coupling of pilot wire monitoring	4 - 12
Figure 4.9	Logic diagram of the functions related to the pilot wire monitoring	4 - 14
Figure 4.10	Logical diagram of the emergency overcurrent function	4 - 15
Figure 5.1	Check set nominal voltage of the integrated power supply	5 - 4
Figure 5.2	Check of selected control voltages of binary inputs 1 to 3 on the p.c.b.	5 - 5
Figure 5.3	Standard connection L1-L3-E	5 - 7
Figure 5.4	Connection L1-L2-L3 with reduced earth-fault sensitivity	5 - 7
Figure 5.5	Connection L1-L3-E with increased earth-fault sensitivity	5 - 7
Figure 5.6	Matching unequal primary currents	5 - 8
Figure 5.7	Two-phase connection L1-L3	5 - 8
Figure 5.8	Connection of isolating transformer 7XR9513 or 7XR9514	5 - 10
Figure 5.9	Excerpt from the menu tree: Selection of configuration blocks	5 - 13
Figure 5.10	Excerpt from the menu tree: Selecting configuration block for the protective functions	5 - 18
Figure 5.11	Excerpt from the menu tree: Example for selecting marshalling of binary inputs	5 - 21
Figure 6.1	Front view of 7SD600 with control panel and displays	6 - 3
Figure 6.2	Selection of parameters for the system and station data	6 - 4
Figure 6.3	Trip characteristic of the 7SD600	6 - 11

C

Contents

	page
Figure 6.4 Selection of the event blocks	6 - 19
Figure 6.5 Example for displaying events in the display	6 - 19
Figure 6.6 Measuring of the pilot wire resistance	6 - 36
Figure 6.7 Checking the earth current path	6 - 39
Figure 7.1 Fuse of the power supply	7 - 3
Figure A.1 Overview diagram of the differential protection 7SD600*-*B***- and 7SD600*-*E***- ...	A - 1
Figure A.2 Position of the jumper section of R_x	A - 2
Figure A.3 Standard connection L1-L3-E, suitable for all networks	A - 3
Figure A.4 Connection L1-L2-L3 with reduced earth-fault sensitivity, preferable for effectively earthed networks with particularly low zero sequence impedance	A - 4
Figure A.5 Connection L1-L3-E with increased earth-fault sensitivity, preferable for low resistance earthed networks	A - 5
Figure A.6 Adaptation of unequal primary currents, example with standard connection L1-L3-E	A - 6
Figure A.7 Connection to two current transformers L1-L3, only for insulated or resonant-earthed networks	A - 7
Figure A.8 Connection example for two isolating transformers 7XR9513 or 7XR9514	A - 7

page

Tables

Table 2.1	Selection and order data	2 - 6
Table 3.1	General device data	3 - 1
Table 3.2	Mechanical details	3 - 2
Table 3.3	Electrical tests	3 - 3
Table 3.4	Mechanical tests	3 - 4
Table 3.5	Climatic Stress	3 - 4
Table 3.6	Line differential protection	3 - 6
Table 3.7	Transfer trip function	3 - 8
Table 3.8	Lockout function	3 - 8
Table 3.9	Emergency overcurrent protection	3 - 8
Table 3.10	Additional functions	3 - 8
Table 3.11	Power consumption in the current circuit for standard connection L1-L3-E (Figure 5.3) relating to through fault nominal current (device 7SD600 is in operation)	3 - 9
Table 3.12	Summation transformer 4AM4930	3 - 10
Table 4.1	Types of faults and winding factors for standard connection L1-L3-E	4 - 3
Table 5.1	Marshallable binary input functions	5 - 23
Table 5.2	Factory set binary inputs	5 - 24
Table 5.3	Marshallable binary output functions	5 - 25
Table 5.4	Factory set indications on signal relay	5 - 26
Table 5.5	Factory set LEDs	5 - 27
Table 5.6	Factory set command functions	5 - 29
Table 6.1	Current factors for summation transformers	6 - 31
Table 6.2	Measured currents with incorrect CT connection	6 - 38
Table A.9.1	Pick-up time of the saturation detector depending on the maximum through fault current relative to the rated line current	A - 34

1 Introduction

1.1 Application

The numerical line differential protection 7SD600 is a fast and discriminative short-circuit protection for cables and overhead lines of all voltage levels, irrespective of the method of neutral-point connection.

For example, it is particularly suited for short lines where the reach of a distance protection cannot be set small enough, or for meshed industrial and reticulation networks. It can be implemented no matter how short the line. A current transformer, but not a voltage transformer, is required at each end of the line.

A significant advantage of the differential protection is that, in the event of a short circuit, it trips and immediately disconnects, no matter where the short circuit occurs within the protected zone. The current transformers at both ends define the protected zone. It is this strict zone definition which produces the ideal discrimination typical of the differential protection principle. It also means that it is not necessary to delay the trip command as is usually the case with time-graded protection systems.

The complete setup requires a 7SD600 device and a 4AM4930 summation transformer at each end of the protected line. In order for the devices to work together, a symmetrical pilot wire pair is required between the two stations.

For the protection to function properly, the pilot wires must be healthy. For this reason, we always recommend pilot wire monitoring. This can disable the differential protection (optional) if a fault is detected on the transmission link and outputs a corresponding indication.

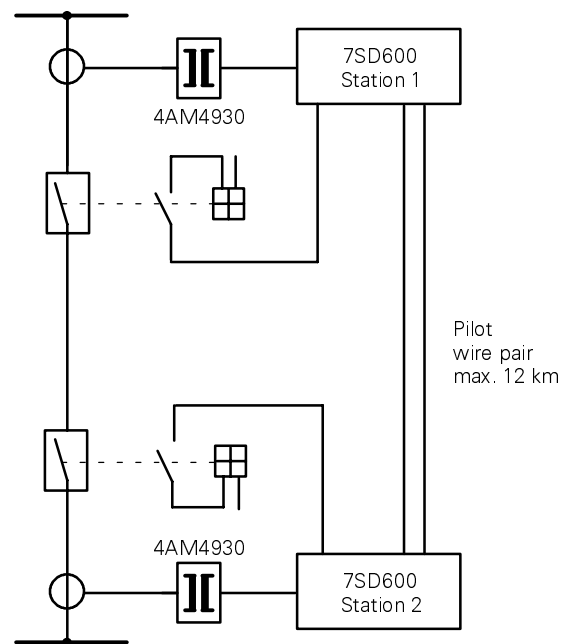

Figure 1.1 Line differential protection 7SD600 for operation with two pilot wires, block diagram

In cases where a transformer is connected directly to a cable or overhead line, i.e. without a circuit-breaker, current transformers should be installed at the transformer terminal, and the 7SD600 connected solely as a line protection. The integrated stabilization with the second harmonic in the differential current implies that, that a transformer may, in principle, be included in the protected zone of the 7SD600, however, it does not offer the level of sensitivity provided by a transformer differential protection.

In addition, this arrangement causes a delay of the tripping time for the 7SD600.

During a system fault (short-circuit in the protected zone), the instantaneous values of the measured signals are stored in the device for a maximum period of 5 s and are subsequently available for fault analysis. For this purpose, the 7SD600 is equipped with an RS485 interface with bus-capability so that, with the DIGSI 3 operating program, user-friendly operation as well as convenient and clear fault recording and evaluation is possible. The interface is also suited for operation through a modem connection.

Both hardware and software are constantly monitored in the device so that faults are detected and indicated immediately. This ensures an extremely high level of reliability and availability.

The device cannot operate in conjunction with 7SD24 or 7SD502 but must always be implemented in pairs. The previously used summation transformer 4AM49 can continue to be used if the device used to replace a 7SD24.

1.2 Features

- Numerical device with powerful 16-bit microprocessor system;
- Complete numerical measured value processing and control, from the sampling and digitization of measured variables through to the trip decisions for the circuit-breaker;
- Complete galvanic and interference-free isolation of the internal processing circuits from the measuring, control and supply circuits of the station and the pilot wires by means of screened measured value transducers, binary in and output modules and DC converters;
- Self-contained measuring unit for each line end;
- Low demands on the current transformer;
- Comprehensive additional functions (see section 1.3);
- Continuous calculation and display of operational measured values at the front of the device;
- Simple operation via integrated keypad and display panel or via connected PC with DIGSI 3;
- Storage of fault events and instantaneous values for disturbance recording;
- Data exchange with remote station via a symmetrical pilot wire pair; thus enabling implementation of existing pilot wires;
- Communication with central control and storage device via serial interface;
- Connection to fiber optic cable via external RS485/opt. module
- Continuous monitoring of signal path and measured signals, as well as all device hardware and software;
- Simple installation and commissioning, integral commissioning aids;
- Low maintenance.

1.3 Functional scope

The numerical line differential protection 7SD600 offers the following functions:

Differential protection

- Absolutely discriminative protection for all kinds of short circuits in earthed, isolated-neutral or resonant-earthed systems,
- Stabilization against current transformer transformation errors in the event of external short-circuits,
- Additional dynamic stabilization in the event of different degrees of current transformer saturation,
- Stabilization with second harmonic is possible, thus enabling incorporation of a transformer or compensation reactor,
- In the event of single-end infeed, optional disconnection of only the infeed line end or, via the transfer trip function, also at the non-infeed line end,
- Measured value transmission via a symmetrical pair of pilot wires,
- Compensation of pilot wire resistances by computational adaptation of sensitivity
- Continuous monitoring of pilot wires with a modulated AF signal (optional)
- Combination of differential protection-trip command with an overcurrent release is possible,
- The differential protection-trip command can be maintained until manual reset via a binary input or local operation (Lockout function).

Remote tripping

- Tripping at the remote line end by an external signal, e.g. from a circuit-breaker failure protection (version with pilot wire monitoring).

Emergency overcurrent protection

- If the differential protection becomes inactive due to a pilot wire failure the relay has as an option an emergency overcurrent function. It includes one definite time overcurrent trip stage and can be delayed.

The functional scope also includes the following

- Continuous monitoring of the internal measuring circuits, the auxiliary power supply, as well as all protection hardware and software; thus increased reliability,
- Measuring and test routines during normal load operation, measurement of operational, differential and stabilizing current,
- Event storage for the last eight system faults (system disturbances), with real-time tag,
- Data storage for disturbance recording: thus fast fault analysis, detailed fault logging,
- Commissioning aids, such as connection check, pilot wire resistance,
- Monitoring of differential current below the differential protection pick-up value in order to detect any interruptions in the current transformer circuits.

2 Design

2.1 Models

All protection functions, including the converter, are installed on a p.c.b. in double-height Eurocard format. This p.c.b., combined with a locating plate (guide rail), a connector (on the board) and a front panel, constitute the device's plug-in module. This is installed in a 7XP20 housing. The studs on the locating plate, the spacers on the p.c.b. and the shape of the connector all serve to ensure that the plug-in module is correctly guided in the housing. The interior of the housing is un-lacquered and the electrical properties of the housing material are such that it can carry out discharging and shielding functions. The module is linked to the housing interior by means of contact springs with a large contact area which establishes an earth contact before the plug connection is made. An unlacquered contact point is available on the housing, for the attachment of a copper band using two earth screws to establish a low-resistance large area contact.

The housing has protection class IP51, the terminals have IP21.

Three different housing models are currently available.

- 7SD600★-★B★★- in housing 7XP20 with terminals on the side of the housing for panel surface mounting

The housing consists of a sheet-metal tube and a connector with four holes on the rear plate for attachment to the control panel.

All external signals lead to this connector on the housing which latches onto the rear panel of the housing and is directly connected to the screw terminals (i.e. without intermediate wiring). Each electrical connection has a screw terminal able to accommodate a maximum of two ring-lugs. If preferred, up to two wires (different cross-sections permitted) can be secured directly to the terminal without ring-lugs. Only copper wires should be used.

For dimensions, see Figure 2.1.

- 7SD600★-★D★★- in housing 7XP20 with terminals on top and bottom for **panel surface mounting**

The housing consists of a sheet-metal tube, a rear plate and two metal brackets for attachment to the control panel or in the cubicle.

All external signals lead to two-tier screw terminals which are located below and above on the perforated covers. The terminals are consecutively numbered from left to right on each tier.

For dimensions, see Figure 2.2.

- 7SD600★-★E★★- in housing 7XP20 with terminals at the rear for **panel flush mounting** or **cubicle mounting**

The housing consists of a sheet-metal tube, a rear plate and two metal brackets for attachment to the control panel or in the cubicle.

All external signals lead to the connector (on the housing) which latches into an opening on the rear plate of the housing. Each electrical connection is equipped with a screw terminal able to accommodate a maximum of two ring-lugs, and parallel to that, a plug-in connection (crimp snap-on connector). Use of the screw terminals for the wiring is recommended, as the plug-in connectors require special tools. Only use copper wires.

For housing dimensions, see Figure 2.3.

2

Design

2.2 Dimensions

Figures 2.1 to 2.4 show the dimensions of the different models.

7SD600★-★B★★ Housing for **panel surface mounting** 7XP20 with terminals on the sides.

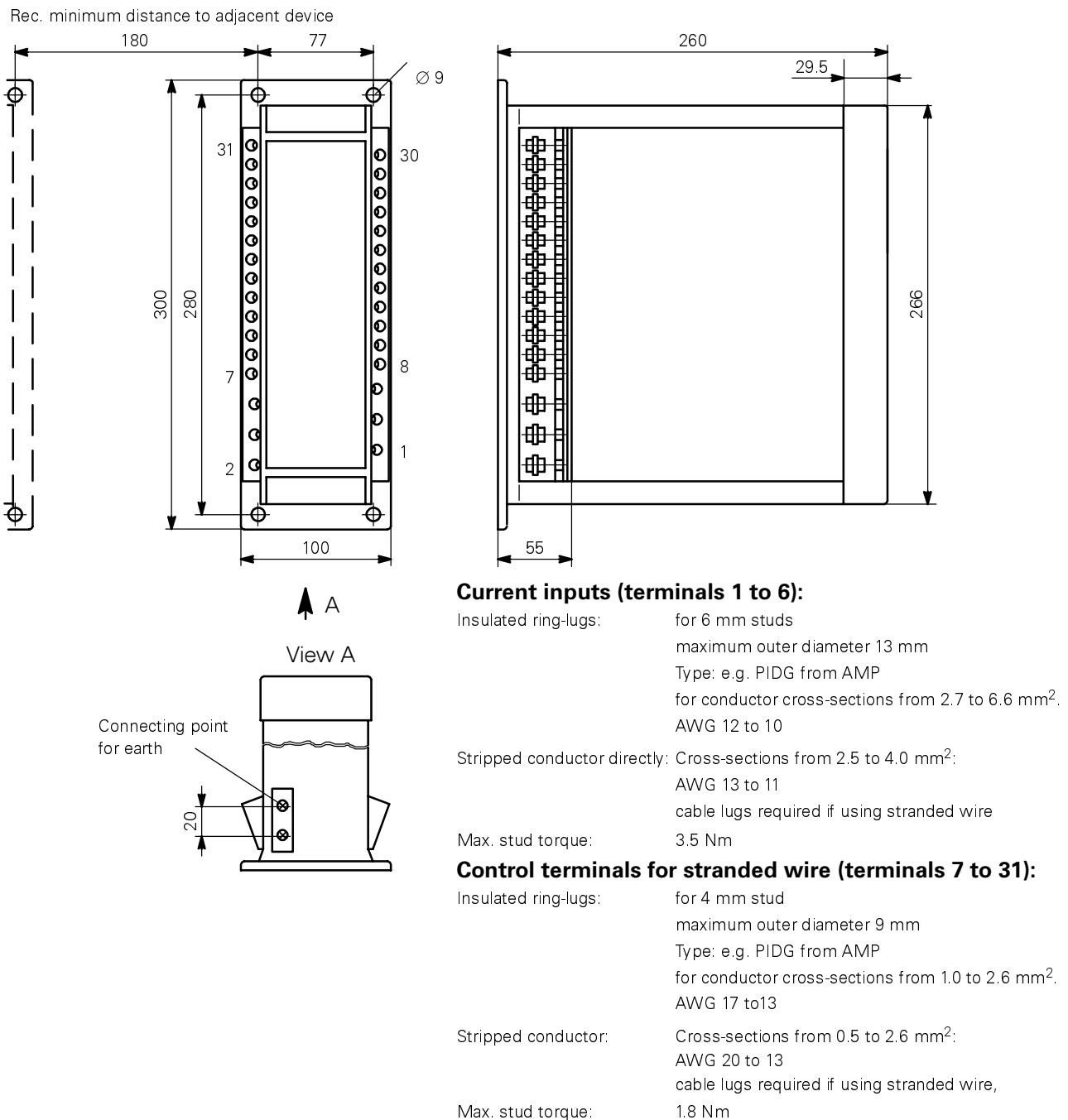
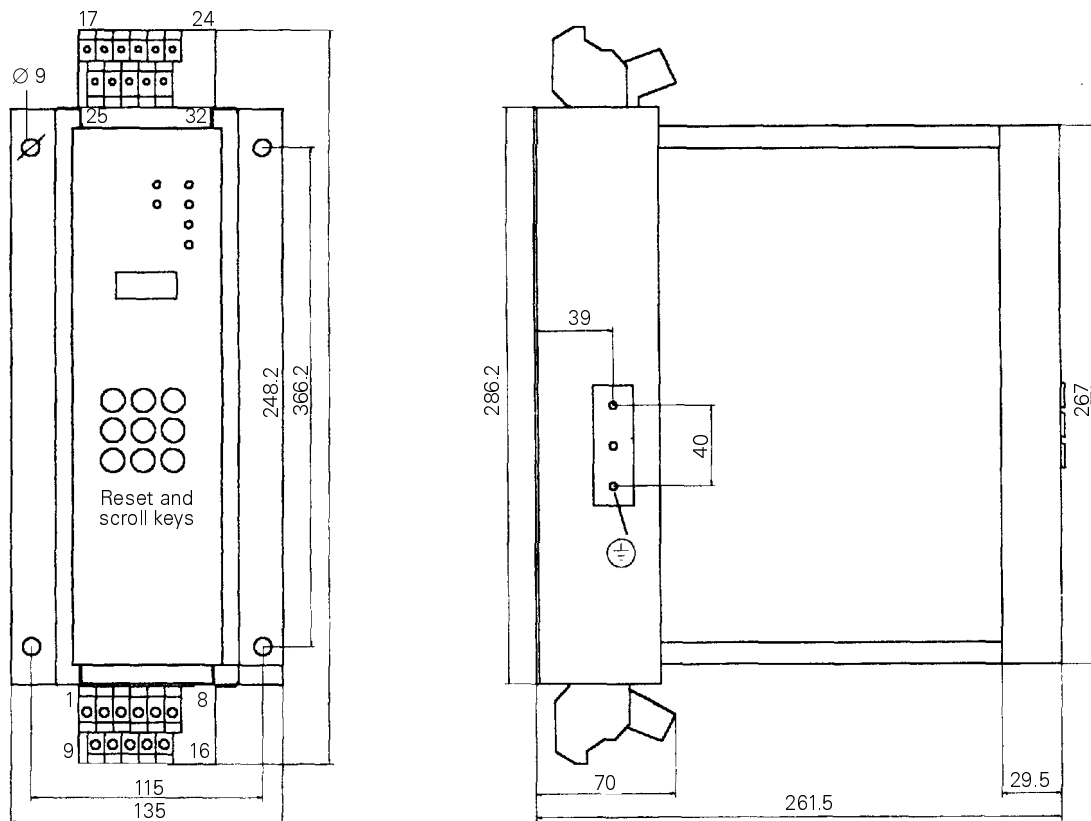

Figure 2.1 Dimensioned drawing of 7XP20 for panel surface mounting with terminals on the sides (dimensions in mm)

7SD600★-★D★★ in housing for **panel surface mounting** 7XP20 with terminals at top and bottom



Max. 32 terminals with a connecting cable cross-section of max. 7 mm².

The housing must be mounted on the control panel using studs or M6 bolts.
If M8 studs are already present (e.g. if replacing a device), use slot nuts.

Measurements in mm

Figure 2.2 Dimensioned drawing of 7XP20 for panel surface mounting with terminals at top and bottom

2 Design

7SD600★-★E★★★ housing for **panel flush mounting** or cubicle mounting 7XP20

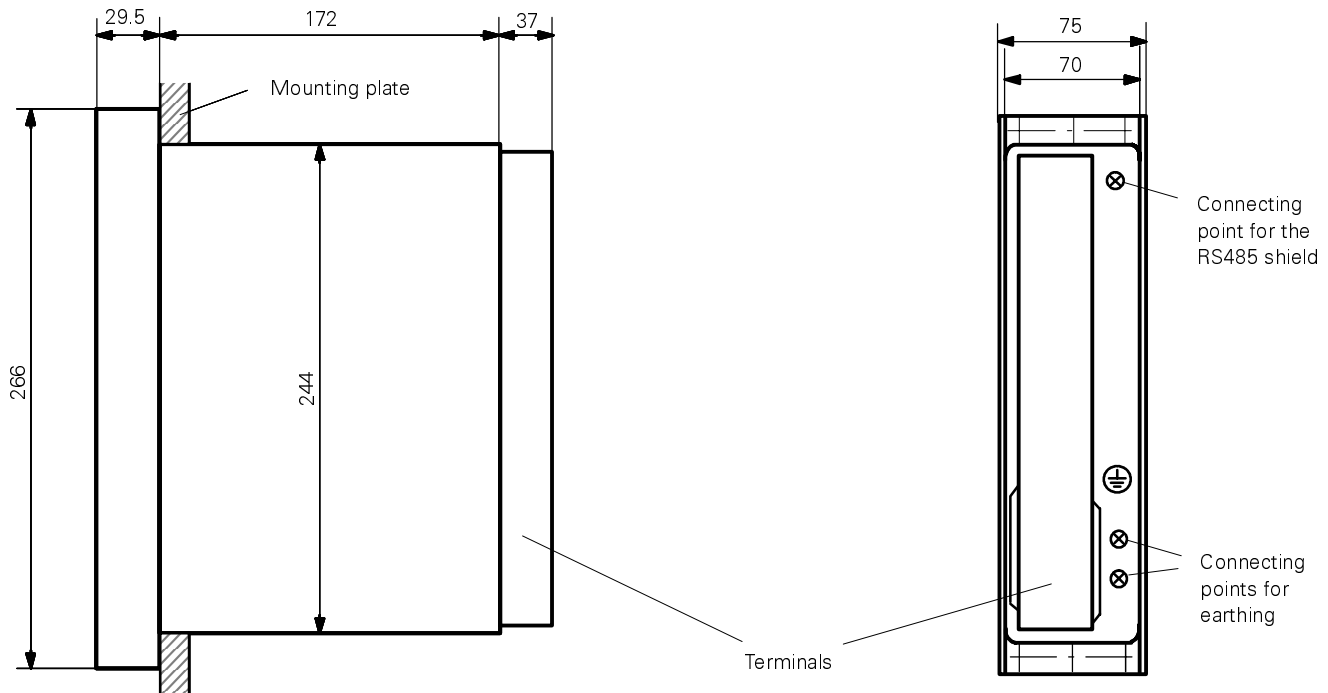

Section of control panel

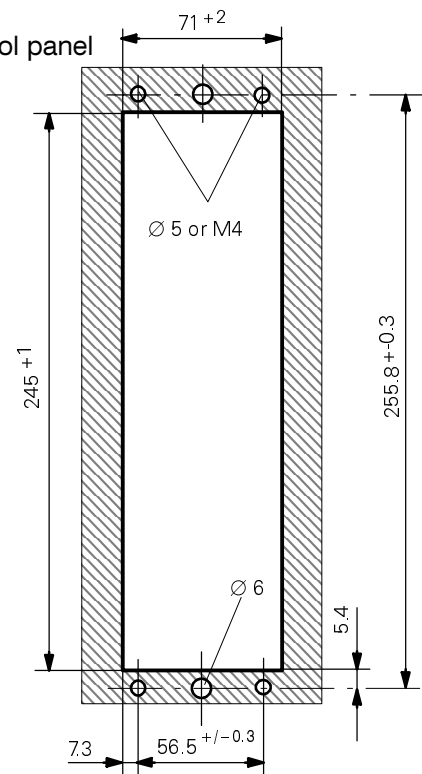

Current inputs (terminals 1 to 6):

Screw terminal (ring-lug): for 6 mm studs
 maximum outer diameter 13 mm
 type: e.g. PIDG from AMP
 for conductor cross-sections from 2.7 to 6.6 mm²
 AWG 12 to 10

Parallel to this double flat-spring crimp contact: for conductor cross-sections from 2.5 to 4.0 mm²
 AWG 13 to 11

Max. stud torque: 3.5 Nm

Control terminals (terminals 7 to 31):

Screw terminal (ring-lug): for 4 mm studs
 maximum outer diameter 9 mm
 type: e.g. PIDG from AMP
 for conductor cross-sections of 1.0 to 2.6 mm²
 AWG 17 to 13

Parallel to this, double flat-spring crimp contact: for conductor cross-sections of 0.5 to 2.5 mm²
 AWG 20 to 13

Max. stud torque: 1.8 Nm

Figure 2.3 Dimensioned drawing of 7XP20 for panel flush mounting or cubicle mounting (dimensions in mm)

2.2.1 Summation transformer 4AM4930

The summation transformer 4AM4930 is equipped with screw terminals max. 4 mm² and parallel 6.3 mm double flat spring contacts. 2 brackets are provided for mounting.

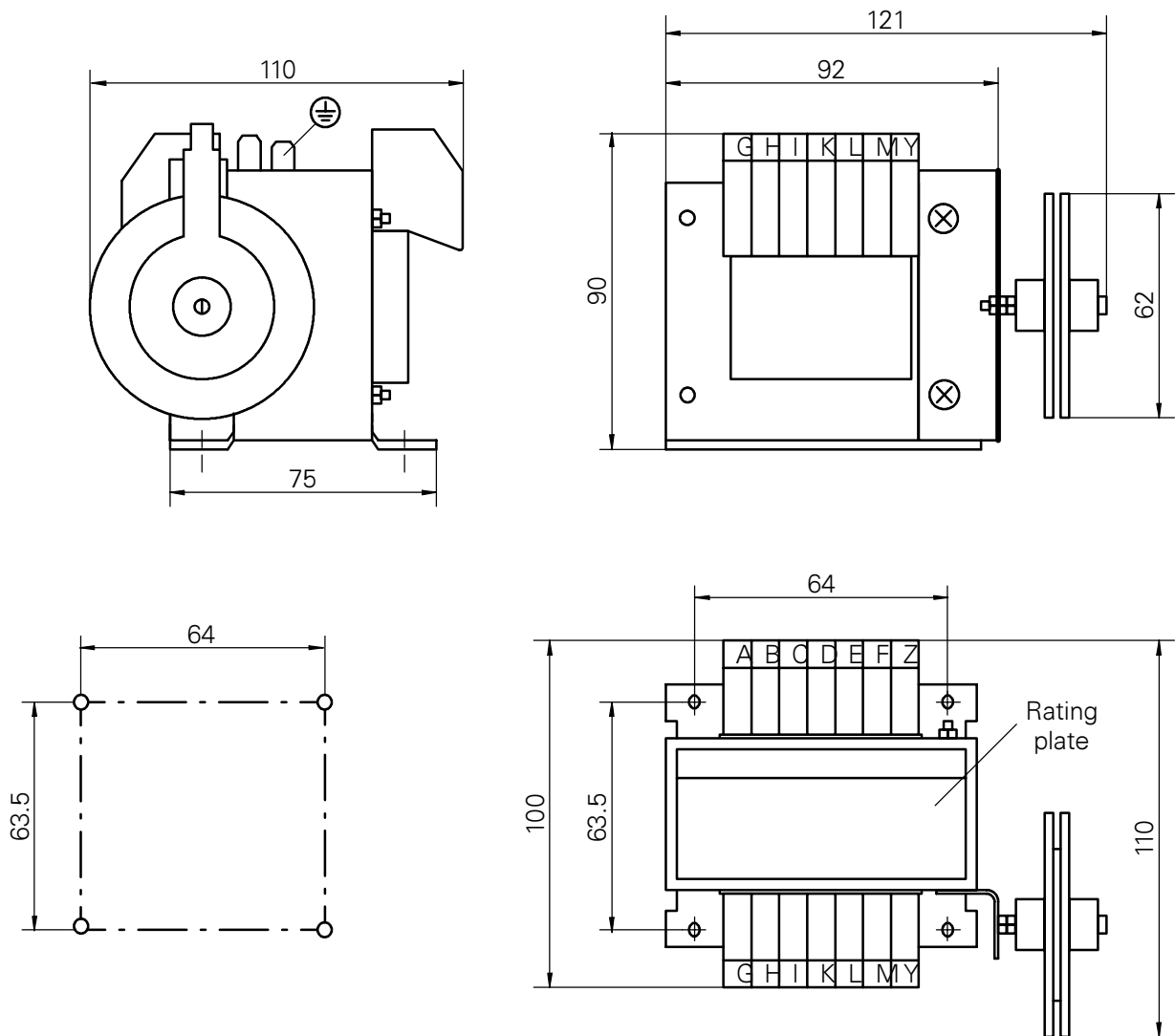

Figure 2.4 Dimensioned drawing of the 4AM4930

2 Design

2.3 Order data

Table 2.1 Selection and order data

		Order no.	
		1 7 8 9 10 11 12 13 14 15 16	
Numerical line differential protection		7SD600	□ - □ □ A 0 0 - □ D A 0
Nominal current; nominal frequency		↑	
20 mA; 50/60 Hz (without external summation transformer)		0	
1 A 50/60 Hz; with external summation transformer 4AM4930-7DB00-0AN2		1	
5 A 50/60 Hz; with external summation transformer 4AM4930-6DB00-0AN2		5	
Nominal auxiliary supply voltage			
24, 48 V-			
60, 110, 125 V			
220/250 V-/115 V~, 50/60 Hz		2	
		4	
		5	
Constructional details			
in housing for panel surface mounting with terminals at the side			
in housing for panel surface mounting with terminals at the top/bottom			B
in housing for panel flush mounting/cubicle mounting			D
			E
Operating language			
English - can be changed to German			0
Functional scope			
Differential protection			0
Differential protection, harmonic restraint			1
Differential protection, pilot wire monitoring, transfer tripping			2
Differential protection, pilot wire monitoring, transfer tripping, harmonic restraint			3
Accessories			
<ul style="list-style-type: none"> • Copper connection cable between PC (9-pin socket) and converter/protection device • Converter RS232 - RS485 with 2.5 m connection cable, PC adapter with plug-in power supply unit 110/220 V- • Converter full-duplex fiber optic cable - RS485 with 2.5 m connection cable, with auxiliary supply voltage 24 to 250 V- and 110/220 V~ • Protection operating software DIGSI Parameterization and operating software (English) Min. requirements: MS WINDOWS V3.1, WINDOWS 95 or WINDOWS NT 4.0 • Graphic evaluation program DIGRA for visualization of fault recording in connection with DIGSI (English); Min. requirements: MS WINDOWS V3.1, WINDOWS 95 or WINDOWS NT 4.0 and DIGSI • Summation transformer 1 A, type 4AM4930-7DB00-0AN2 • Summation transformer 5 A, type 4AM4930-6DB00-0AN2 • Barrier transformer 5 kV for galvanic isolation of the relay from the pilot wires • Barrier transformer 20 kV for galvanic isolation of the relay from the pilot wires 		7XV5100-2	
		7XV5700-0AA00	
		7XV5650-0AA00	
		7XS5120-1AA0	
		7XS5130-1AA0	
		4AM4930-7DB	
		4AM4930-6DB	
		7XR9514	
		7XR9513	

3 Technical Data

Table 3.1 General device data

Current input circuits	Nominal current I_N	20 mA without summation transformer 1 or 5 A with external summation transformer		
	Nominal frequency f_N Thermal rating of current circuit continuous for 10 s for 1 s	50/60 Hz settable $2 \times I_N$ $30 \times I_N$ $100 \times I_N$		
Auxiliary supply voltage Auxiliary power supply with integral converter	Nominal auxiliary DC voltage U_{H-} Permissible voltage range	24/48 V-	60/110/125 V-	220/250 V-
	Superimposed a.c. voltage, peak-to-peak Power consumption quiescent picked-up	19 to 58 V- 48 to 150 V- 176 to 300 V- ≤ 12 % at nominal voltage ≤ 6 % at the voltage range limits approx. 2 W approx. 4 W		
	Bridging time in the event of power failure/short-circuit of the auxiliary supply voltage Nominal auxiliary a.c. voltage U_{H-} Permissible voltage ranges	≥ 50 ms (for $U_H \geq 110$ V) ≥ 20 ms (for $U_H \geq 24$ V-) 115 V~ 88 to 133 V~		
Command contacts (Trip)	No. of relays	2 (marshallable)		
	Contacts per relay	2 or 1 make contact(s)		
	Switching capacity make break	1000 W/VA 30 W/VA		
	Switching voltage permissible current continuous 0.5 s	250 V 5 A 30 A		
Signaling contact	No. of relays	3 (2 marshallable)		
	Contacts per relay	1 CO contact		
	Switching capacity make break	1000 W/VA 30 W/VA		
	Switching voltage Permissible current	AC/DC 250 V 5 A		
Binary inputs	Number	3 (marshallable)		
	Nominal voltage range Power consumption, picked-up	24 to 250 V- approx. 2.5 mA, depending on operating voltage		
	Operating points for nominal voltages 24/48/60 V- U_{rising} U_{falling} for nominal voltage 110/125/220/250 V- U_{rising} U_{falling}	adjustable via pluggable links ≥ 17 V- <8 V- ≥ 74 V- <45 V-		

3

Technical Data

Table 3.1 General device data

Serial interface	Standard	isolated RS485
	Test voltage	3.5 kV-
	Connections	via conductor to housing terminals, two lines for data, 1 earthing cable, for connection of a PC or similar device lines must be shielded, shield must be earthed.
	Transmission speed	Pre-setting 9600 baud min. 1200 Baud; max. 9600 Baud

Table 3.2 Mechanical details

Mechanical details	Housing	7XP20; see section 2.1
	Dimensions	see section 2.2
	Weight	
	in housing for panel surface mounting	approx. 4.5 kg
	in housing for control panel/cubicle mounting	approx. 4 kg
Protection class to EN 60529		
housing	IP 51	
terminals	IP 21	

3.1 Standards and Directives

Table 3.3 Electrical tests

<p>CE conformity, regulations</p>	<p>The product is herewith confirmed to comply with the requirements set out in the Council Directive on the Approximation of the Laws of the Member States relating to Electromagnetic Compatibility (89/336/EEC) and the Use within Certain Voltage Limits (73/23/EEC). The evaluation has been carried out in accordance with the international standards of the IEC 60255 series and the national standard DIN 57 435/Part 303.</p> <p>The device has been developed and manufactured for industrial use to EMC standards.</p>	<p>This conformity is the result of a test carried out by SIEMENS AG in accordance with article 10 of the Directive which complies with the basic specifications of EN 50081 and EN 50082 for the EMC Directive and EN 60255-6 for the Low Voltage Directive.</p>
<p>Insulation Tests Standards: IEC 60255-5; ANSI/IEEE C37.90.0</p>	<p>Voltage test (routine test), all circuits except auxiliary supply voltage and RS485</p> <p>Voltage test (routine test), only auxiliary supply voltage and RS485</p> <p>Surge voltage test (type test), all circuits Class III</p>	<p>2.5 kV (r.m.s. value), 50 Hz</p> <p>3.5 kV-</p> <p>5 kV (peak value), 1.2/50 μs, 0.5 J, 3 positive and 3 negative impulses at intervals of 5 s</p>
<p>EMC Tests for Interference Immunity (type tests) IEC 60255-6, IEC 60255-22 (International Product Standards) EN 50082-2 (Basic Specification) DIN 57435 Part 303 (German Product Standard for Protection Devices)</p>	<p>High Frequency Disturbance Test IEC 60255-22-1, VDE 0435 Part 303; Class III</p> <p>Static Electricity Discharge IEC 60255-22-2; IEC 61000-4-2; Class III</p> <p>Radiated HF Field Interference, Amplitude-Modulated IEC 61000-4-3; Class III, IEC 60255-22-3; Class III</p> <p>Radiated HF Field Interference, Pulse-Modulated IEC 61000-4-3/ENV 50204; Class III</p> <p>Fast Transient Interference/Burst IEC 60255-22-4; IEC 61000-4-4; Class III</p> <p>Conducted High Frequency, Amplitude-Modulated IEC 61000-4-6; Class III</p> <p>Magnetic Field with Power Engineering Frequency IEC 61000-4-8; Class IV; IEC 60255-6;</p>	<p>2.5 kV (peak); 1 MHz; $\tau = 15 \mu$s; 400 impulses per s; test duration 2 s</p> <p>4/6 kV contact discharge; 8 kV air discharge; both polarities; 150 pF; $R_f = 330 \Omega$</p> <p>10 V/m; 80 to 1000 MHz; 80 %; AM 1 kHz</p> <p>10 V/m; 900 MHz; repetition frequency 200 Hz; ED 50 %</p> <p>2 kHz; 5/50 ns; 5 kHz, burst duration = 15 ms; repetition rate 300 ms; both polarities; $R_f = 50 \Omega$, test duration 1 min</p> <p>10 V; 150 kHz to 80 MHz; 80 % AM; 1 kHz</p> <p>30 A/m; continuous; 300 A/m for 3 s; 50 Hz; 0.5 mT</p>
<p>Further EMC Tests for Interference Immunity (type tests)</p>	<p>Oscillatory Surge Withstand Capability ANSI/IEEE C37.90.1</p> <p>Fast Transient Surge Withstand Capability ANSI/IEEE C37.90.1</p> <p>Radiated Electromagnetic Interference ANSI/IEEE C37.90.2</p> <p>Damped Vibration similar to IEC 61000-4-12</p>	<p>2.5 to 3 kV (peak); 1 to 1.5 MHz, damped wave; 50 impulses per s; duration 2 s; $R_f = 150$ to 200Ω</p> <p>4 to 5 kV; 10/150 ns; 50 impulses per s; both polarities; duration 2 s; $R_f = 80 \Omega$</p> <p>3.5 V/m; 25 to 1000 MHz;</p> <p>2.5 kV (peak, alternating polarities); 100 kHz, 1, 10 and 50 MHz, damped wave; $R_f = 50 \Omega$</p>
<p>EMC Tests on Emitted Interference EN 50081-* (Basic Specification)</p>	<p>Radio Interference Voltages on Lines, only auxiliary supply voltage, EN 55022, DIN VDE 0878 Part 22, IEC CISPR 22</p> <p>Interference Field Strength EN 55011, DIN VDE 0875 Part 11, IEC CISPR 11</p>	<p>150 kHz to 30 MHz, Limit Class B</p> <p>30 to 1000 MHz, Limit Class A</p>

3

Technical Data

Table 3.4 Mechanical tests

Vibration and Shock Stress during Stationary Use IEC 60255-21-1, IEC 60068-2	Vibration IEC 60255-21-1, Class II IEC 60068-2-6	Sinusoidal 10 to 60 Hz, ± 0.075 mm amplitude; 60 to 150 Hz; 0.5 g acceleration; frequency sweep 1 octave/min; 20 cycles in 3 axes vertical to one another
	Shock IEC 60255-21-2, Class I	Semi-sinusoidal Acceleration 5 g, duration 11 ms, per 3 shocks in both directions of the 3 axes
	Vibration during Earthquake IEC 60255-21-3, Class 1 IEC 60068-3-3	Sinusoidal 1 to 8 Hz: ± 3.5 mm amplitude 8 to 35 Hz: 1 g acceleration 1 to 8 Hz: ± 1.5 mm amplitude 8 to 35 Hz: 0.5 g acceleration Frequency sweep 1 octave/min 1 cycle in 3 axes, vertical to one another
	hor. axis vert. axis	
Vibration and Shock Stress during Transport IEC 60255-21, IEC 60068-2	Vibration IEC 60255-21-1, Class II IEC 60068-2-6	Sinusoidal 5 to 8 Hz: ± 7.5 mm amplitude; 8 to 150 Hz: 2 g acceleration; frequency sweep 1 octave/min; 20 cycles in 3 axes, vertical to one another
	Shock IEC 60255-21-2, Class 1 IEC 60068-2-27	Semi-sinusoidal 15 g acceleration, duration 11 ms, per 3 shocks in both directions of the 3 axes
	Bump IEC 60255-21-2, Class 1 IEC 60068-2-29	Semi-sinusoidal 10 g acceleration, duration 16 ms, per 1000 shocks in both directions of the 3 axes

Table 3.5 Climatic Stress

Climatic Stress EN 60255-6 IEC 60255-6 VDE 0435 Part 303	Limit temperature	during operation (recommended) during storage during transport	-20 to +70 °C -5 to +55 °C -25 to +55 °C -25 to +70 °C	(Readability of display may be impaired upwards of 55 °C)
	Storage and transport with works packaging!			
	Humidity stress during operation		Yearly mean ≤ 75 % relative humidity, on 56 days in the year up to 95 % relative humidity, moisture condensation not permissible	

We recommend that the devices are installed so that they are not subject to direct sunlight and strong fluctuations in temperature which could lead to moisture condensation.

3.2 Operating conditions

The protection device is designed for industrial use, i.e. for installation in conventional relay rooms and stations so that, if correctly installed, **electromagnetic compatibility (EMC)** is ensured. The following is also recommended:

- Contactors and relays which operate within the same cabinet or on the same relay board as the digital protection equipment must always be fitted with suitable suppression filters.
- In the case of switchgear > 110 kV, external connecting leads should be used with a shielding which is earthed on both sides and has a current carrying capacity. As a rule, no special measures are required for medium-voltage switchgear.
- The shield of the RS485 line must be linked with earth potential.

- Never remove or plug in individual modules when live. Once removed, some devices are still electrostatic sensitive; please ensure compliance with ESD regulations (for electrostatic sensitive devices) when handling. There is no danger when the devices are properly installed.



Warning

The device is not designed for implementation in residential buildings as defined in the Standard EN 50081.

3

Technical Data

3.3 Line differential protection

Table 3.6 Line differential protection

Setting ranges	Current threshold I_1 (trip release with local current)	$I/I_{N \text{ line}}$	0.00 to 1.50 (step 0.01)
	Differential current	$I_{\text{DIFF}}/I_{N \text{ line}}$	0.50 to 2.50 (step 0.01)
	Delay time	T_{DLY}	0.00 to 60.00 s (step 0.01 s)
Response characteristics	Stabilization with 2nd harmonic	I_{2fN}/I_{fN}	see Figure 3.1 10 to 80 %
	Resetting ratio		approx. $0.7 \cdot \text{pick-up value } (I_{\text{stab}} = 0)$
All current values refer to symmetrical current with standard connection.			
Operating times	Pick-up time for two-sided infeed with 4 x setting value		approx. 20 to 28 ms without stabilization by 2 harm approx. 32 to 42 ms with stabilization by 2 harm
	Reset time		approx. 35 ms
Tolerances with pre-settings under reference conditions	Local current threshold		$\pm 3 \%$ of set value, min $0.02 \cdot I_N$
	Differential current		$\pm 5 \%$ of set value, min $0.02 \cdot I_N$
Influencing variables	Auxiliary supply voltage in range $0.8 \leq U_H/U_{HN} \leq 1.15$		$\leq 1 \%$ $\leq 1 \%/10K$
	Temperature in range $0 \text{ }^\circ\text{C} \leq \Theta_{\text{amb}} \leq 40 \text{ }^\circ\text{C}$		$\leq 4 \%$
	Frequency in range $0.9 \leq f/f_N \leq 1.1$		
Pilot wires (1 pilot pair)	Number		2 preferably symmetrical telephone wire pairs with $73 \text{ } \Omega/\text{km}$ loop resistance and $60 \text{ nF}/\text{km}$ capacitance
	Asymmetry of pilot wire pair at 800 Hz		max. 10^{-3}
	Maximum loop resistance		$1200 \text{ } \Omega$
	Permissible induced longitudinal voltages for direct connection with pilot wire for connection via isolating transformer		$\leq 1.2 \text{ kV}$, but max. 60 % of the test voltage of the pilot wires $\geq 1.2 \text{ kV}$, but max. 60 % of the test voltage of the pilot wires and max. 60 % of the test voltage of the isolating transformer
Setting range and delivery of resistance R_x		see appendix A.2	
Pilot wire monitoring and transfer tripping (order option)	Monitoring signal		2000 Hz, pulse code modulation
	Delay of alarm signal		0.2 to 60 s (step 0.1 s)
	Operating time of transfer tripping		approx. 80 ms
	Prolongation of transfer trip signal		0.00 to 5.00 s (step 0.01 s)

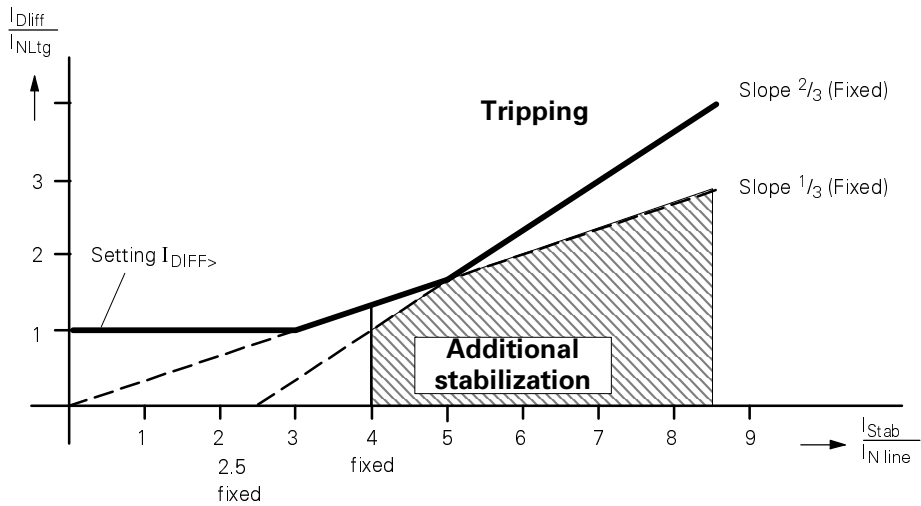

$I_{DIFF} = |I_1 + I_2|$
 $I_{STAB} = |I_1| + |I_2|$
 I_1 = Current at local line end, positive when flowing into line
 I_2 = Current at remote end, positive when flowing into line
 I_{Nline} = Nominal current of line

Figure 3.1 Stabilization characteristic of the differential protection (shown for pre-settings)

3

Technical Data

3.4 Transfer trip function

Table 3.7 Transfer trip function

Tripping of the remote line end only available for devices with pilot wire monitoring		
Setting ranges	Prolongation time for transmission to remote station	0.00 to 60.00 s (step 0.01 s)
	Delay time of the received signal from remote station	0.00 to 60.00 s (step 0.01 s)
	Prolongation time of the received signal from remote station	0.00 to 60.00 s (step 0.01 s)
Tolerances	Delay time/reset delay time	1 % or 10 ms
Operating time	Transmission time without delay	approx. 80 ms

3.5 Lockout function

Table 3.8 Lockout function

Hold trip command	for differential protection and remote tripping	until resetting
Reset	via binary input and/or local operation	

3.6 Emergency overcurrent protection

Table 3.9 Emergency overcurrent protection

Setting ranges	Overcurrent trip stage	$I_1/I_{N \text{ line}}$	0.10 to 15 (step 0.1)
	Delay time	$T_{I_1 >}$	0.00 to 60.00 s (step 0.01)

3.7 Additional functions

Table 3.10 Additional functions

Operational measured values	Operating currents	$I_1; I_2; I_{\text{Diff}}; I_{\text{Stab}}$
	Measuring range	0 to 240 % I_N
	Tolerance (I_1)	3 % of nominal value or of measured value
Fault event recording	Storage of last 8 faults	
Time tagging	Resolution for operational events	1 s
	fault events	1 ms
	Max. time deviation	0.01 %

Fault analog value storage max. 8 faults	Storage time (from start or trip command)	Max. of overall 5 s, pre and post fault settable
	Max. length per recording	T_{max} 0.30 to 5,00 s (step 0.01 s)
	Pre-fault time	T_{pre} 0.05 to 0.50 s (step 0.01 s)
	Post-fault time	T_{post} 0.05 to 0.50 s (step 0.01 s)
	Sampling rate at 50 Hz	1 instantaneous value per 1.66 ms
	Sampling rate at 60 Hz	1 instantaneous value per 1.39 ms
Circuit-breaker test		by test tripping

3.8 Summation transformer 4AM4930

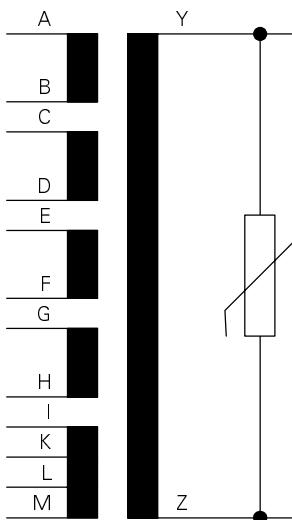

Figure 3.2 Summation transformer 4AM4930

Table 3.11 Power consumption in the current circuit for standard connection L1-L3-E (Figure 5.3) relating to through fault nominal current (device 7SD600 is in operation)

I_n		In phase (VA)		
		L1	L2	L3
1 A	Single-phase, approx.	2.2	1.3	1.7
	Three-phase symmetrical, approx.	0.6	0.2	0.35
5 A	Single-phase, approx.	3.5	1.5	2.2
	Three-phase symmetrical, approx.	0.7	0.2	0.5

3

Technical Data

Table 3.12 Summation transformer 4AM4930

	Connections	4AM4930 - 7DB00 - 0AN2				4AM4930 - 6DB00 - 0AN2			
Nominal current	A to M	1 A				5 A			
Number of turns									
• Primary windings	A-B	5				1			
	C-D	10				2			
	E-F	15				3			
	G-H	30				6			
	I-K	30				6			
	K-L	30				6			
	L-M	60				12			
• Secondary windings	Y-Z	1736				1736			
Thermal rating		nominal	conti- nuous	for 10 s	for 1 s	nominal	conti- nuous	for 10 s	for 1 s
• Continuous current in amperes	A-B	4.5				20			
	C-D	4.5				20			
	E-F	4.5				20			
	G-H	4.5	* 1.2	* 10	* 30	20	* 1.2	* 10	* 30
	I-K	1.2				6.5			
	K-L	1.2				6.5			
	L-M	1.2				6.5			
	Y-Z	0.2				0.2			
Nominal current, secondary for standard connection in accordance with Figure 5.3 and with 3-phase symmetrical current	Y-Z	20 mA				20 mA			

4 Method of Operation

4.1 Overall function

The numerical line differential protection 7SD600 is equipped with a powerful 16-bit microprocessor which enables full digital processing of all tasks, from the acquisition of measured values through to trip command initiation to the circuit-breaker.

Figure 4.1 shows the basic structure of the device.

In the case of symmetrical nominal current flow, the summation transformer 4AM4930 outputs a single-phase current of 20 mA from the currents coming from the current transformer. Due to the unbalanced number of turns of the input windings, with the ratio of 2 : 1 : 3, each type of fault produces a defined single-phase AC current which decisively influences the protection functions of the device.

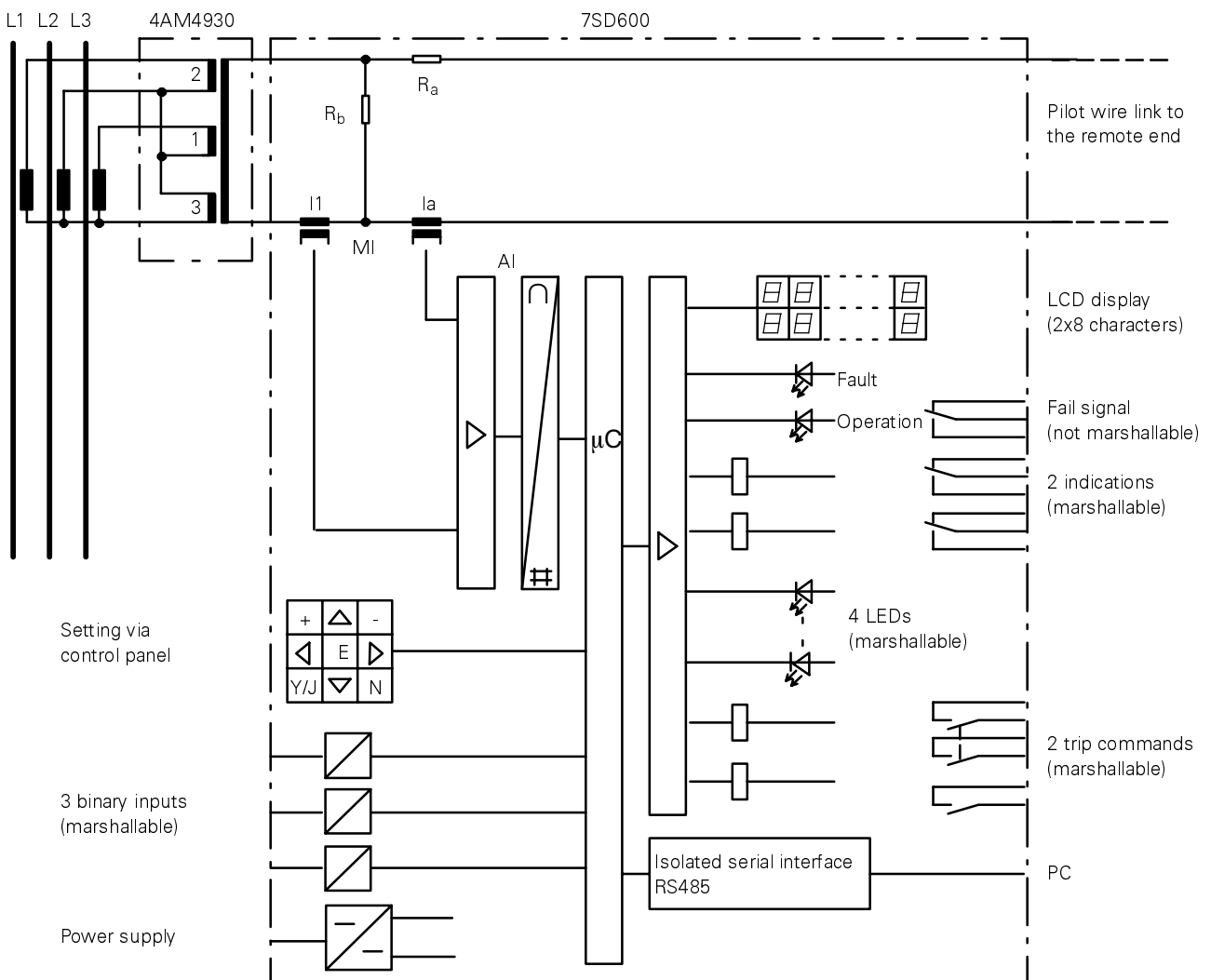

Figure 4.1 Hardware structure of the line differential protection 7SD600

The transformers of the measurement input group MI transform the currents I_1 (summation current of local line end) and I_a (pilot wire current) and match them to the internal processing level of the device. As well as the transformers providing complete galvanic and low-capacitance isolation, filters are installed for the suppression of interference. These filters are optimized for measured value processing in terms of bandwidth and processing speed. The modified analog signals are passed to the analog input AI.

The analog input AI contains input amplifiers sample and hold elements for each input, multiplexers, analog/digital converters, as well as memory for the transfer of data to the microprocessor.

The micro processor system not only controls and monitors the measured signals, but also processes the actual protection functions. These, in particular, include the following:

- Filtering and conditioning of measured signals,
- Continuous calculation of values relevant for protection starting,
- Calculation of tripping and stabilization currents,
- Frequency analysis of the measured signal differential, recognition of current transformer saturation and sequential faults,
- Checking of pilot wires (devices with pilot wire monitoring),
- Interrogation of thresholds and timing sequences,
- Decision on trip commands,
- Storage and output of events and disturbance record data for fault analysis.

Binary inputs and outputs from and to the processor are controlled by the input/output modules. This is where the processor gets information from the station (e.g. remote resetting) or from other devices. The main outputs are trip commands to the circuit-breakers, indications for the remote indication of important events and states, as well as optical displays (LED) and an alphanumeric display panel on the front.

Communication with the device is via an integrated keypad and alphanumeric LCD display panel which enables the input of all data required for operating, such as setting values, station data, etc. These parameters can also be read out here, and after a system disturbance, the relevant data for analysis can be read off. A rear RS485 interface also enables communication via PC.

A suitably rated power supply feeds the described function modules with the necessary +5 V. Short-time interruptions of the supply voltage of up to 50 ms in the case of $U_H \geq 110 \text{ V}$, which can occur in the event of short-circuits in the station's DC supply system, are bridged by a DC buffer.

4.2 Summation transformer 4AM4930

The summation transformer 4AM4930 summates the secondary currents of the main current transformer and transforms them to a secondary nominal current

of 20 mA. Figure 4.2 shows the standard connection of the 4AM4930.

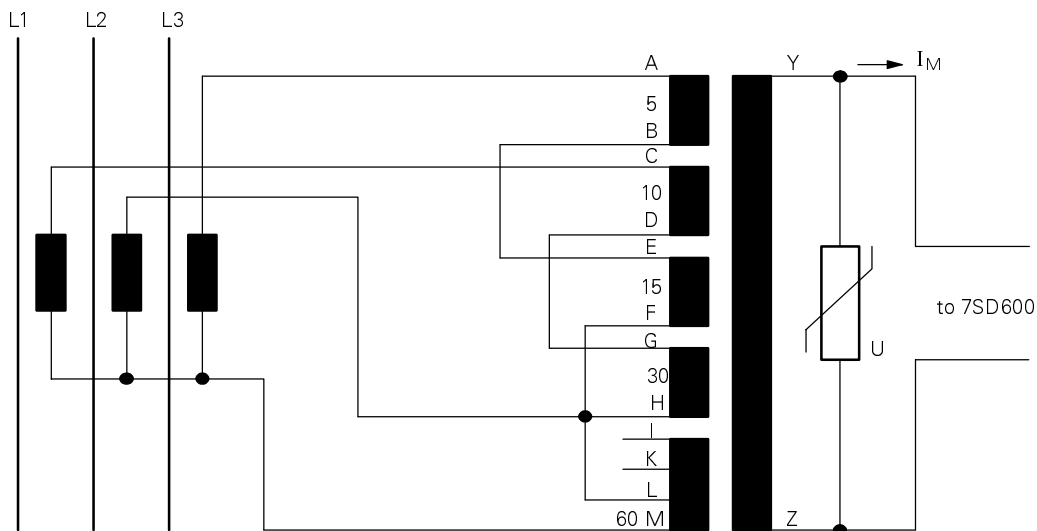

Figure 4.2 Standard connection of summation transformer 4AM4930

The connection shown in Figure 4.2 results in a winding factor W for the various types of fault with a ratio relative to a three-phase symmetrical fault according to table 4.1. The primary current I_1 required to produce the 20 mA secondary current which is derived from the reciprocal value of W is also shown. Multiplying the setting values by these factors will give you the actual pick-up value.

It is clear from the table that the line differential protection 7SD600 is more sensitive to single or double earth faults than to short-circuits without earth. This increased sensitivity is because the winding I_E (see Figure 4.2), of the summation transformer, located in the neutral conductor has the largest number of turns so that the the earth current is input with the winding factor 3.

Table 4.1 Types of faults and winding factors for standard connection L1-L3-E

Fault	W	$W/\sqrt{3}$	I_1 for $I_M = 20 \text{ mA}$
L1-L2-L3 (sym.)	$\sqrt{3}$	1.00	$1.00 \times I_N$
L1-L2	2	1.15	$0.87 \times I_N$
L2-L3	1	0.58	$1.73 \times I_N$
L3-L1	1	0.58	$1.73 \times I_N$
L1-E	5	2.89	$0.35 \times I_N$
L2-E	3	1.73	$0.58 \times I_N$
L3-E	4	2.31	$0.43 \times I_N$

Due to the difference in the number of primary turns and the various taps on the winding, different connections are possible. Connections for double earth fault preference, earth fault sensitivity, transformation ratio matching, different summation ratios and other main CT terminations (e.g. two-phase connection may be selected).

4 Method of Operation

If the connection is changed so that it no longer complies with Figure 4.2, it must be noted that the same connection must be used at both line ends, and that it is essential to ensure compliance with the technical data of the 7SD600 (e.g. thermal rating).

Figure 4.3 shows connection of the 4AM4930 to 2-current transformers (only for isolated-neutral or resonant-earthed system).

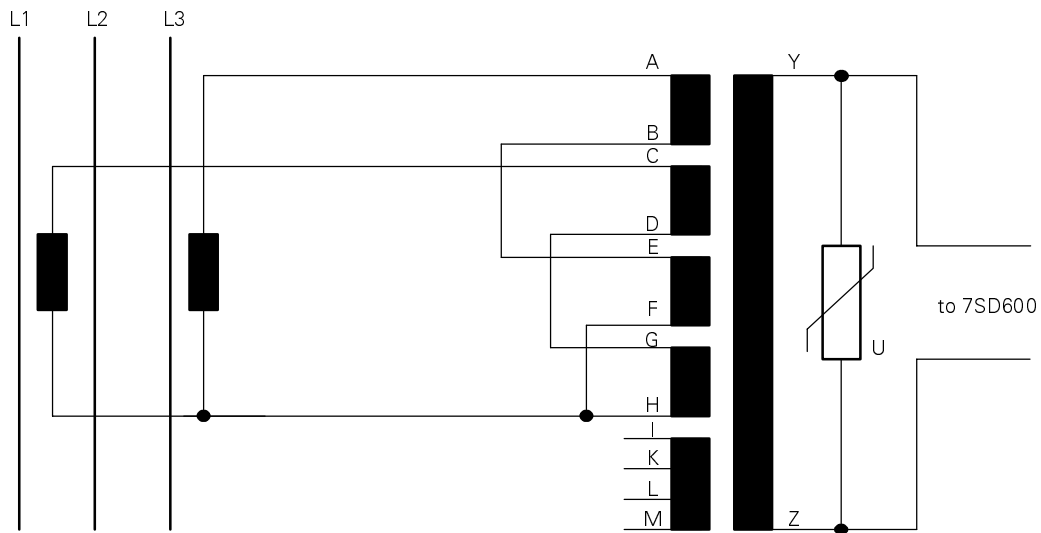

Figure 4.3 Connection of summation transformer 4AM4930 to 2-current transformers in isolated-neutral systems or systems which are not effectively earthed.

4.3 Line differential protection

The line differential protection 7SD600 operates according to the current comparison principle. To achieve this, a device must be installed at each end of the protected line. The two 7SD600 devices must be linked to one another by pilot wires. Thus, the differential protection system comprises the two 7SD600 devices installed at each line end, a summation transformer and the pilot wires linking the devices.

The simple configuration shown in Figure 4.4 therefore ensures reliable operation of the protection in the event of a short-circuit in the protected zone if the fault current flowing is sufficient to pick-up the measuring element M.

4.3.1 Principle of differential protection

Differential protection is based on a current comparison which is why it is also known as current comparison protection. This utilizes the fact that, in the unfaulted state, a line **L** (see Figure 4.4) carries the same current \underline{I} (dotted line) at both ends. The current flows in at one side of the zone under consideration and leaves again at the other side. A current difference is a definite sign of a fault within the line. Providing they have the same ratio, the secondary windings of the current transformers W1 and W2 at the line ends can be linked to produce a closed electric circuit with the secondary current \underline{i} such that, in an unfaulted state, a measuring element M in the cross connection link carries no current. In the event of a fault in the area defined by the current transformers, the measuring element carries a current $\underline{i}_1 + \underline{i}_2$ which is proportional to the fault currents $\underline{I}_1 + \underline{I}_2$ flowing in from both sides.

4.3.2 Stabilized differential protection

If external faults result in large currents flowing through the protected zone, any transformation differences in the saturation region of current transformers W1 and W2 will cause a differential current to flow in the measuring element M which could cause tripping. Stabilization prevents this type of protection malfunction.

In the case of differential protection for protected plants with two ends, stabilization is achieved by using the sum of the magnitudes $|\underline{I}_1| + |\underline{I}_2|$. This requires the formation of a geometrical sum at each line end and the formation of the sum of the magnitudes of the currents flowing at the two ends. This serves to define:

a tripping or differential current

\underline{I}_{Diff} in the tripping sense, while \underline{I}_{Stab} opposes this. The processing of these currents is described in section 4.3.4.

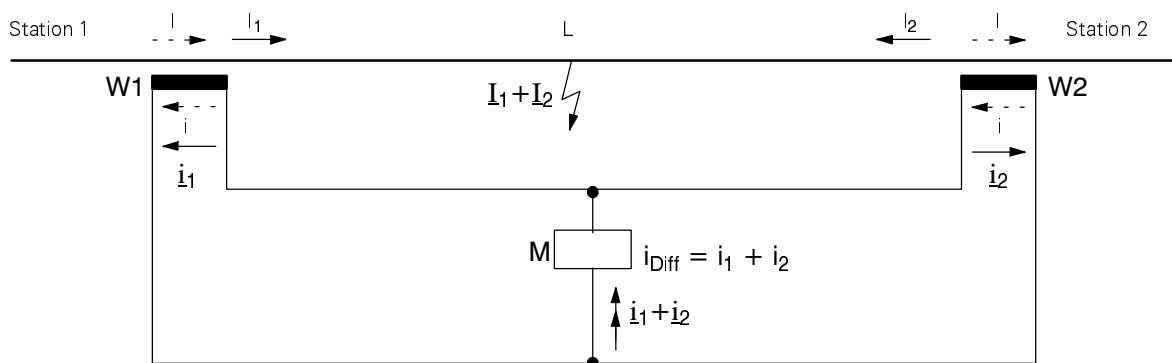

Figure 4.4 Basic principle of differential protection

4 Method of Operation

4.3.3 Formation of measured values for line differential protection with two pilot wires

Figure 4.5 shows the differential current measurement with two pilot wires and measurement of three currents at each end

I_1 is the local line current,

I_a is the current flowing through the pilot wire loop.

The tripping and stabilizing quantities are determined as follows from the measured currents by taking into account the device-internal resistances R_a and R_b and the loop resistance of the pilot wires R_x (set as a parameter in the relay):

The voltage drops in the dotted loop are summated as follows

$$\begin{aligned} (I_1 - I_a) \cdot R_b - I_a \cdot (R_x/2 + R_a) + \\ (I_2 - I_a) \cdot R_b - I_a \cdot (R_x/2 + R_a) = 0 \end{aligned}$$

For the sake of simplicity, the following shall apply:

$$\begin{aligned} R_b &= R && \text{(reference resistance)} \\ R_x/2 + R_a &= x \cdot R && \text{(longitudinal resistance)} \end{aligned}$$

This results in the following loop equation

$$(I_1 - I_a) \cdot R - 2 \cdot I_a \cdot x \cdot R + (I_2 - I_a) \cdot R = 0$$

Cancellation of R and rearranging produces

$$(I_1 + I_2) - 2 \cdot I_a \cdot (1 + x) = 0$$

or

$$I_1 + I_2 = 2 \cdot (1 + x) \cdot I_a$$

This is the differential current. In order to determine the stabilizing current, the current at the remote line end is required. The following applies

$$I_2 = (I_1 + I_2) - I_1 = 2 \cdot (1 + x) \cdot I_a - I_1$$

Thus, all the quantities required for the differential protection are available:

$$\begin{aligned} I_{\text{Diff}} &= |I_1 + I_2| = |2 \cdot (1 + x) \cdot I_a| \\ I_{\text{Stab}} &= |I_1| + |I_2| = |I_1| + |2 \cdot (1 + x) \cdot I_a - I_1| \end{aligned}$$

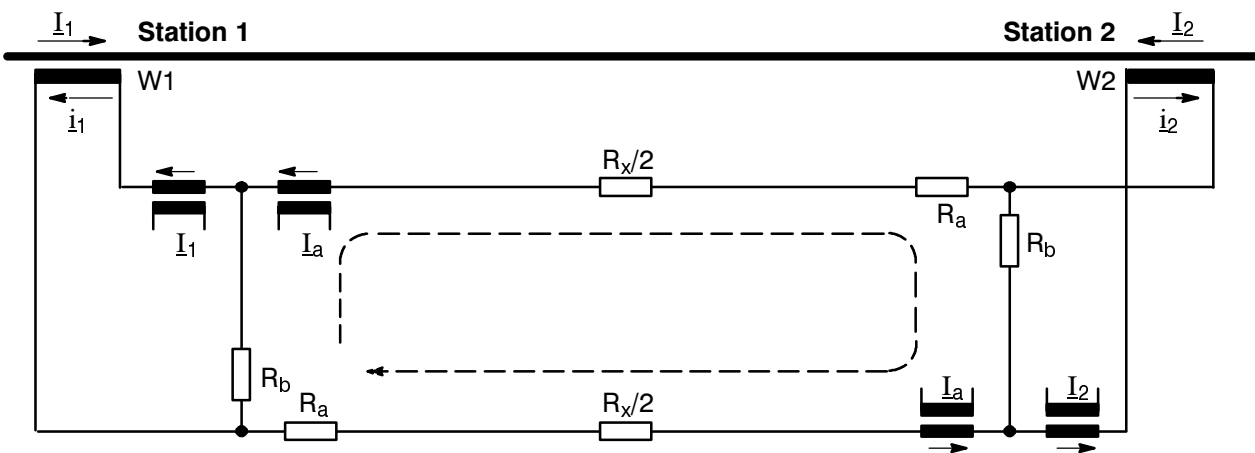

Figure 4.5 Differential protection with two pilot wires - flow chart

4.3.4 Measured value processing

The differential and stabilizing current are determined from the sampled values of the currents. The differential current is filtered to pass the fundamental wave in order to suppress DC components and higher harmonics. The fundamental frequency component of the differential current and the r.m.s. value of the stabilizing current are calculated for the evaluation.

To explain the method of operation, three important states with ideal measured values are looked at:

1. Through-current with healthy line or external fault:

I_2 flows out of the line, i.e. $I_2 = -I_1$;

and $|I_2| = |I_1|$

$$I_{Diff} = |I_1 + I_2| = |I_1 - I_1| = 0$$

$$I_{Stab} = |I_1| + |I_2| = |I_1| + |I_1| = 2 \cdot |I_1|$$

No tripping quantity ($I_{Diff} = 0$); the stabilization (I_{Stab}) corresponds to double the through-current.

2. Internal short-circuit, infeed from both sides with e.g. equal currents:

$I_2 = I_1$ then applies; as well as $|I_2| = |I_1|$

$$I_{Diff} = |I_1 + I_2| = |I_1 + I_1| = 2 \cdot |I_1|$$

$$I_{Stab} = |I_1| + |I_2| = |I_1| + |I_1| = 2 \cdot |I_1|$$

Tripping quantity (I_{Diff}) and stabilizing quantity (I_{Stab}) are of equal magnitude and correspond to the overall through fault current.

3. Internal short-circuit, infeed from one side only:

The following then applies $I_2 = 0$

$$I_{Diff} = |I_1 + I_2| = |I_1 + 0| = |I_1|$$

$$I_{Stab} = |I_1| + |I_2| = |I_1| + 0 = |I_1|$$

Tripping quantity (I_{Diff}) and stabilizing quantity (I_{Stab}) are of equal magnitude and correspond to the single-end through fault current.

Thus, in the case of an internal fault; $I_{Diff} = I_{Stab}$. The curve for internal faults in the tripping diagram (see Figure 4.6) is represented by a straight line with a 45° inclination. Figure 4.6 shows the overall stabilization characteristic of the 7SD600. The "a" segment of the characteristic represents the sensitivity threshold of the differential protection. Segment "b" considers current proportional measuring errors resulting from transformation errors in the current transformers, summation CTs and input CTs of the device. In the high-current range, where current transformer saturation may occur, segment "c" provides more stabilization. A further, special method of handling current transformer saturation (additional stabilization) is described in section 4.3.5.

The differential protection locates the determined currents I_{Diff} and I_{Stab} in the stabilization characteristic as shown in Figure 4.6. If these quantities correspond to a point within the tripping zone, tripping occurs if the local current exceeds a minimum value (local current threshold, see section 4.3.7).

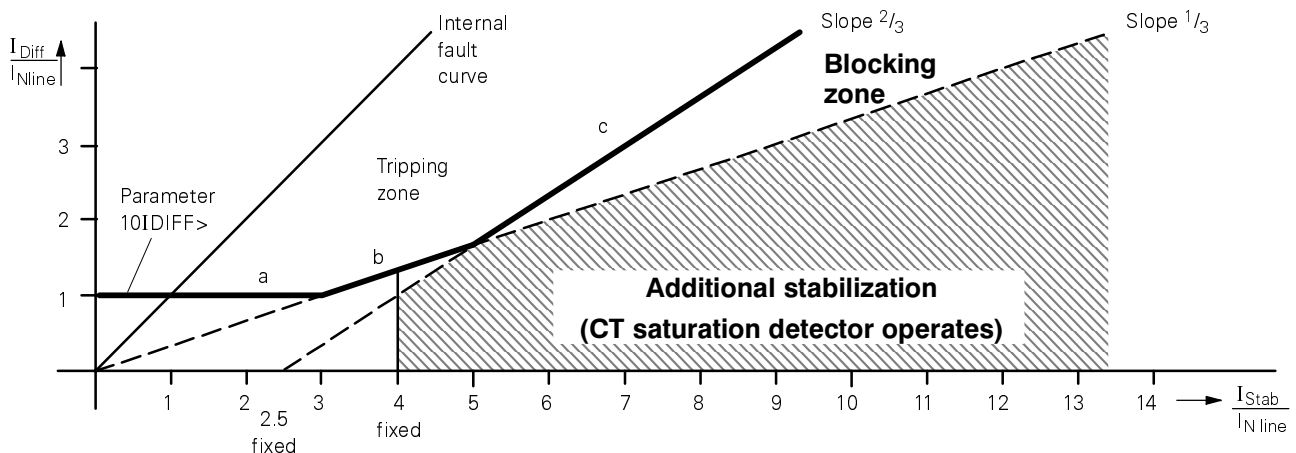

Figure 4.6 Characteristic of the differential protection

4.3.5 Additional stabilization in the case of current transformer saturation

The saturation of the current transformer in the case of high fault currents and/or long system time constants is of practically no significance for an internal short-circuit (on the line to be protected), as the error in the measured value affects the differential current and the stabilizing current in equal measure. The fault characteristic in Figure 4.6 in general, also applies here. Naturally, the secondary current must at least exceed the pick-up threshold of the **10IDIFF** parameter (segment "a" in Figure 4.6), as well as the current threshold (in accordance with section 4.3.6).

In the event of an external fault causing a high passing fault current, current transformer saturation, particularly when of different levels at the two line ends, can simulate a significant differential current which, if the operating point I_{Diff}/I_{Stab} is in the tripping area of the stabilization characteristic (Figure 4.6), would lead to false tripping unless special measures are taken.

7SD600 is equipped with a saturation detector and initializes corresponding stabilizing measures. The saturation detector functions dynamically in the area designated "Additional stabilization" in Figure 4.6.

Current transformer saturation during external faults, is recognized by the fact that initially a large stabilizing current is present, which is located in the area designated as "Additional stabilization" in Figure 4.6. On the other hand, the operating point immediately follows the fault characteristic during an internal fault, as the stabilizing current hardly exceeds the differential current. The saturation detector reaches its decision within a quarter period. The indication **"BLOCK.S"** (Fno. 3024) is then generated which indicates high-current external faults.

If an external fault is recognized, the differential protection is blocked for a maximum of 1 second when the differential current subsequently moves into the tripping area. However, this blocking is canceled as soon as the operating point of the currents is in a steady-state position, i.e. for more than two periods, close to the fault characteristic. This enables fast recognition of sequential faults on the line to be protected.

4.3.6 Local current threshold

The line differential protection 7SD600 has a local current threshold. This represents an additional criterion for tripping and combines the differential protection trip command with an overcurrent criterion.

The current threshold is independent of the threshold for the differential current (segment "a" in Figure 4.6) and can also be set independently (parameter **"10I1REL."**). If only the differential protection criteria must be used, the threshold must be set to "0".

The local current threshold may cause single-ended tripping at the infeed end in the event of internal short-circuits, when there is not infeed from both ends. However, the 7SD600 also enables both-sided disconnection via the intertrip function (see section 4.4), provided that the device is equipped with this function (see section 2.3 order data).

4.3.7 In rush stabilization with second harmonic

In cases where a transformer is directly connected to a line, it is possible to select an in rush stabilization with the second harmonic (parameter **"10HARM2"**). The amount of second harmonic required to activate the stabilization can be set under parameter **"10HARM2"**. The ratio between the second harmonic and the fundamental component of the differential current is compared with the set parameter value.

If the limit is exceeded, the differential protection is blocked (the indication **"BLOCK.H"** (Fno. 3026) is generated).

This blocking is canceled as soon as the differential current exceeds a threshold value (parameter **"10HARM2I"**). The stage **"10IHARM2"** only works in this context and is not a tripping stage.

If the in rush stabilization function is activated, the differential protection is delayed by approx. 15 to 20 ms to enable evaluation of the stabilization with the 2nd harmonic and to generate the blocking indication.

4.3.8 Starting, blocking and tripping logic

As soon as the fundamental component of the differential current reaches 85 % of the set value (parameter "**10IDIFF>**") and the local current threshold (parameter "**10I1REL**") is exceeded, protection start is recognized (indication "**FTdet**", **Fno. 501**, "**DIF.flt**", **Fno. 3022**).

In special applications, it may be desirable to slightly delay the protection trip command. To this, an additional delay can be set (parameter "**10T-DLY**").

A blocking function is provided by the **differential current monitoring "Spill Current"**. There is a monitoring threshold (parameter "**10I-SpC**") for the differential current which is typically set smaller than the rated line current. If this threshold is exceeded for a set time (settable in the range from 5 to 60 s), (parameter "**10-Spc**"), an indication "**B.DIF D**" **Fno. 3030** is output and the differential protection is blocked (starting is suppressed). The blocking is canceled as soon as the differential current drops below this threshold. A hysteresis of 5 percent is provided. The "Spill Current" function can be disabled by setting the monitoring threshold "**10I-SpC**" to infinity (" ∞ ").

This monitoring detects circuit-interruptions (broken conductor) between the summation transformer and the main CT during normal operation, and prevents an

unwanted trip if the test switch is accidentally opened at only one end of the line.

The device is fitted with a **Lockout function** that can be enabled via parameter "**01 L.Out**". With this function, the trip command issued by one of the protection functions (diff. protection, intertrip, remote trip), does not reset when the trip drops off or after a delay time, but is stored permanently.

Failure of the auxiliary supply voltage also leads to a renewal of the TRIP command. This lockout state is signaled and can be marshalled to the LED (indication "**Lockout**" **Fno. 3031**).

It can be reset via the "Reset LED" key or via a binary input programmed to this effect **>Res.LO**, (**Fno. 3008**). Whether this function is carried out via keypad and/or binary input can be set as a parameter "**01L.O.Re**".

The differential protection function may be switched to the states "on", "off" or "ALARM only", depending on parameters and binary inputs.

Furthermore, the actual state of the differential protection is alarmed (parameter "**10DIF.PR**").

Figure 4.7 shows the logic diagram of the differential protection, including the associated binary input and output functions.

4

Method of Operation

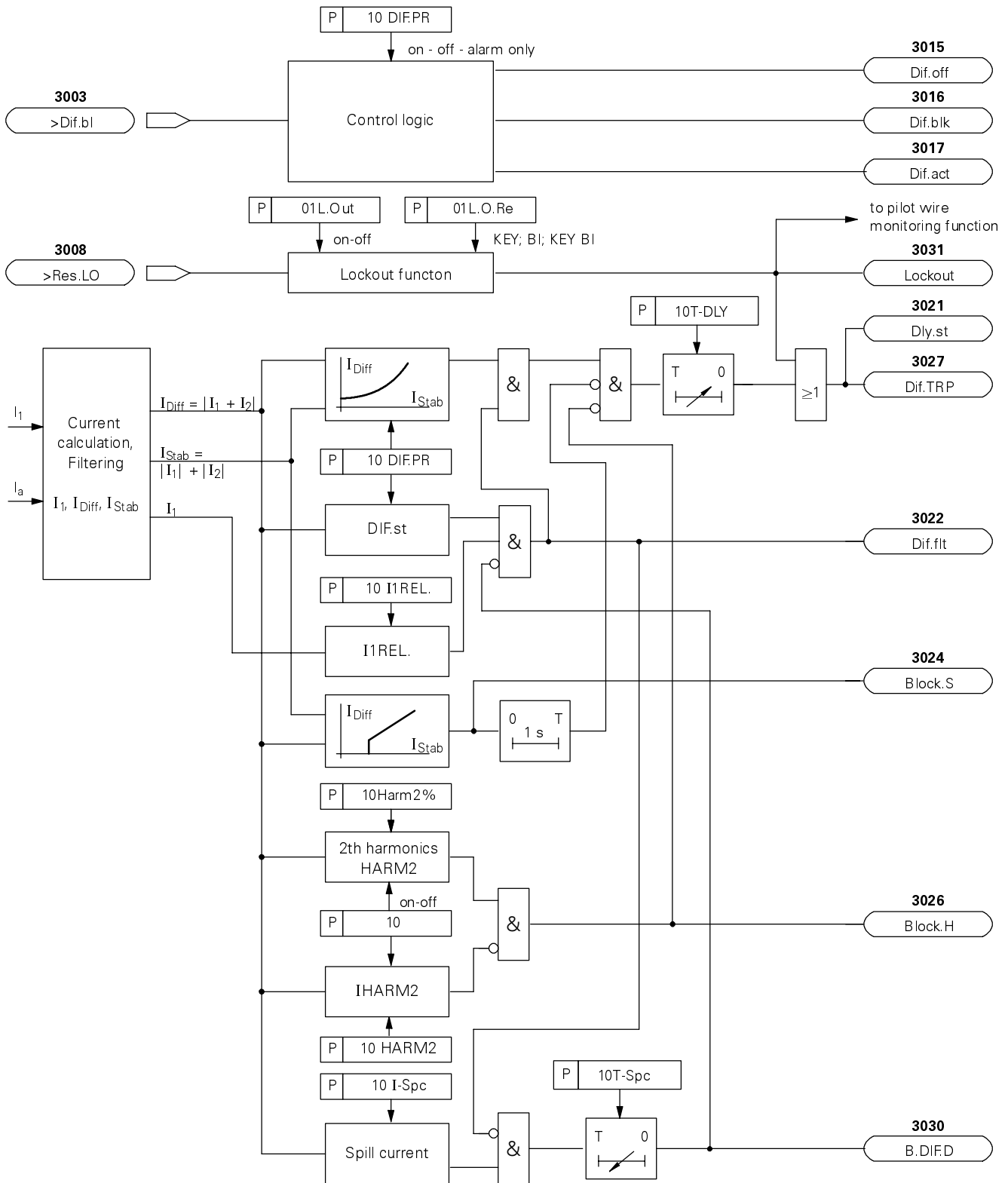

Figure 4.7 Simplified logic diagram of the differential protection

4.4 Pilot wire monitoring (optional), transfer tripping, intertripping

4.4.1 Pilot wire monitoring

The pilot wire connection is an integral part of the differential protection system and the system will only operate properly if it is in perfect condition. Pilot wire failure prevents the functional reliability of the protection. Underground pilot wires laid over great distances are just as prone to mechanical failure as power cables. For this reason, it is important to monitor that the pilot wires are healthy.

Pilot wire monitoring is fitted on a separate p.c.b. (processor-aided pilot wire monitoring) that also contains the transfer tripping and intertripping functions (version 7SD600★--★★★2(3)★★).

Pilot wire monitoring contains a transmitter and receiver in each of the coupled devices (Figure 4.8) and operates with an impulse code modulated onto an injected 2000 Hz current. The monitoring code is alternately transmitted from one device and received by the other and vice versa. In order to ensure a defined startup of this handshake operation, one device is specified as the "master" (higher-level), the other as the "slave" (subordinate) (parameter "11STATN"). The "master" device always starts the signal traffic, the "slave" device responds.

A pilot wire fault is recognized at both ends of the line. In the event of pilot wire interruption, the differential protection no longer trips as the differential current can no longer flow.

In the event of a pilot wire short-circuit and through fault current (external fault), tripping may occur. This can be prevented by blocking the differential protection once a pilot wire fault has been recognized (settable) (parameter "11DIF.BL", "11T-PLT.")

Because pilot wire monitoring is a slow function, it cannot prevent the differential protection responding to a through fault current which occurs at the same time as a pilot wire short-circuit; however, this is rather unlikely as there is no connection between pilot wire short-circuits and *external* line short-circuits.

The pilot wire monitoring function can be disabled (parameter "11PL.MON") or externally blocked (marshalling of binary input ">PWM.bl" (Fno. 3363)). The alarms "PWM off" (Fno. 3371) or "PWM blk" (Fno. 3372) are generated.

If pilot wire monitoring picks up, the alarm "PW.fail" (Fno. 3376) is generated.

If the pilot wire monitoring function is not available ("11PL.MON" off), the transfer tripping and remote tripping are also disabled.

During a fault, the pilot wire monitoring function is idle as the line-frequency comparison current then has priority. It is also not possible to monitor the pilot wires during transmission of a transfer trip signal (see section 4.4.3) as only one pilot wire pair and one carrier frequency are available.

4

Method of Operation

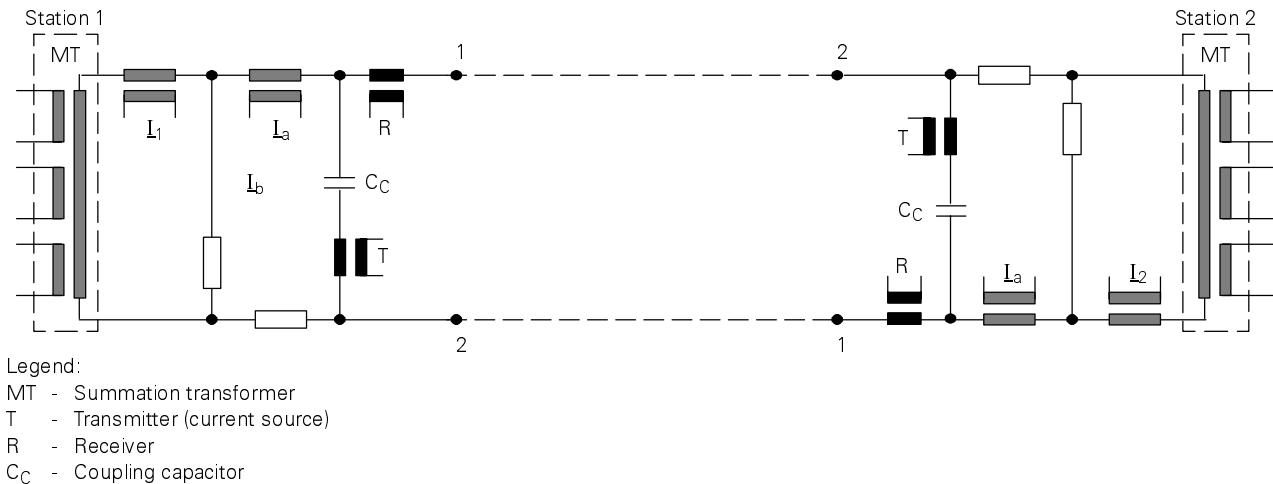

Figure 4.8 Coupling of pilot wire monitoring

4.4.2 Intertrip function

In the event of single-ended infeed, the line is only tripped at the infeed end following a short-circuit on the line, as the local line current may be used as an additional criterion for tripping (see section 4.3.6).

If it is desired to also trip the non-infeeding end, the intertrip function can be enabled (parameter **"10 INT.TR"**). This operates with a pulsed tone frequency via the pilot wires and is therefore only available in devices with tone frequency generator (also used for pilot wire monitoring).

The intertrip signal can be prolonged by setting **"10S.PROL"**. The alarm **"IntTrp" (Fno. 3028)** is generated. The prolongation should be higher than the operating time of the breaker at the infeed side.

4.4.3 Transfer trip function

The 7SD600 line differential protection version with pilot wire monitoring also has an integrated transfer tripping function. This can be implemented for sending a transfer trip to the other line end via a signal generated outside the 7SD600, e.g. by a circuit-breaker failure protection.

The command is then fed to the device via a binary input (marshalling **">Tr.TRP" (Fno. 3306)**). This can be prolonged when it is transmitted to the other line end via the pilot wires, so that even a very short control pulse is reliably received at the other line end (parameter **"12 S.PROL"**).

By marshalling the binary input with the **">TT.blk" (Fno. 3303)** function, the transfer trip function can be blocked.

The transfer trip function generates the following alarms:

- **"TT.blkd" (Fno. 3312)** - function blocked
- **"TT.send" (Fno. 3316)** - signal is transmitted

Similarly, the incoming signal can be delayed and/or prolonged at the receiving line end so that, even in the case of a very short signal, the circuit-breaker can be reliably switched.

The function "Tripping by transfer trip" with the parameters "**13 TR.REC**" (off-on) "**13TR.DLY**" (delay time) is provided for this purpose. This function can be externally blocked (marshalling function "**>Re.blk**", **Fno. 3333**).

Transfer tripping must not be confused with the inter-trip function which is an integral part of the differential protection function (see section 4.4.2).

Only one pilot wire pair and one carrier frequency (2000 Hz) are available for pilot wire monitoring, inter-tripping and transfer tripping. For this reason it is essential to differentiate via impulse code, whether a pilot wire monitoring signal or a trip signal is to be transmitted. Pilot wire monitoring is halted during

transmission of a trip signal (intertripping or transfer tripping).

At the receiving end, no distinction is made between intertrip or transfer, as the impulse code is the same. The reaction of the device is also the same: tripping via receiving signal.

The transfer tripping should only be used in one direction, because in the coincidental event of simultaneous transmission in both directions, overlapping of the two signals would occur. In this case, the conditions for the impulse code would no longer be fulfilled: the received signals would not initialize a tripping.

Figure 4.9 shows the logic diagram of the functions relating to the pilot wire monitoring.

4

Method of Operation

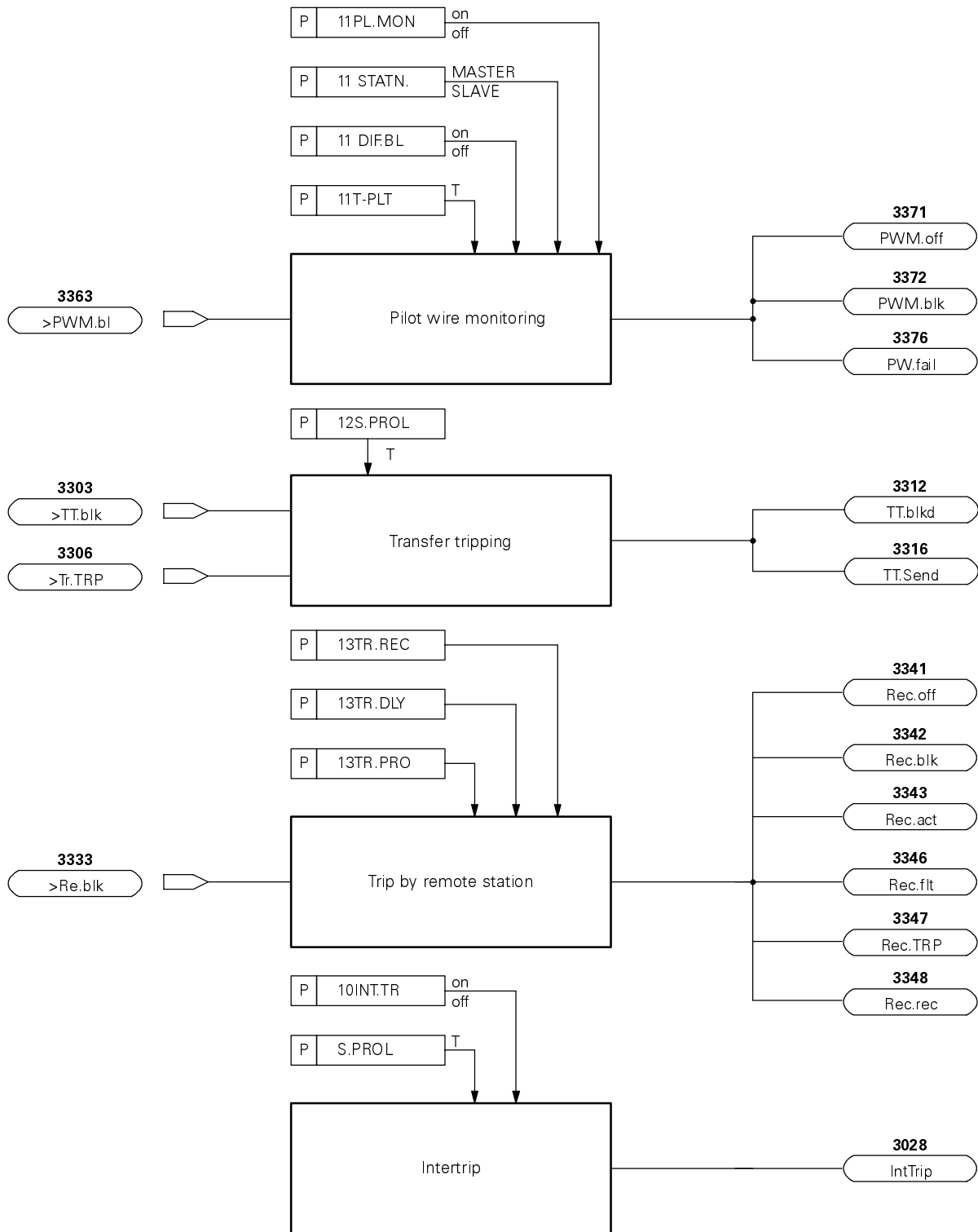

Figure 4.9 Logic diagram of the functions related to the pilot wire monitoring

4.5 Emergency overcurrent function

An emergency overcurrent protection can be activated **"14 E.O/C"**, if the differential function is inactive, that means **"Dif.act G" (Fno. 3017)** is in a raising/going state. There are a few reasons which may inactivate the differential protection. One is to switch off the function **"10 DIF.PR=OFF"** or blocking the function via a binary input **">Dif.bl" (Fno. 3003)**. One cause is the detection of a spill current higher than the setting in **"10 I-SpC"**. The alarm indicating a spill current is **"B.Dif. D" (Fno. 3030)**. This only may occur if the supervision is not set to infinity.

Another reason is a pilot wire failure, detected by the relay. This causes the alarm **"3376 PW.fail" (Fno. 3376)** and leads to a blocking of the differential function if **"11 DIF.BL"** is set to ON. These alarm **"14 E.O/C=Flt.PMW"** can be set as one reason for activating the emergency overcurrent protection.

If the relay is in the emergency overcurrent mode a signal **"EME.act" (Fno. 2053)** is generated. That signal can be marshalled to a contact or LED indication.

If the function **"14 E.O/C"** is set to **OFF** (factory setting) the emergency overcurrent protection doesn't operate.

The overcurrent function uses the summated current I_1 (RMS-value) calculated by the relay behind the summation transformer (see figure 4.5). It is set to a pick-up value **"14 I1>EME"** higher than the symmetrical load current, to avoid a trip during normal operation, if the pilot monitor indicates a failure or the differential function becomes inactive for another reason. A current I_1 , higher than the pick-up threshold is indicated by a fault event **"EME.flt" (Fno. 2061)**. After the delay time set in **"14 T I1"** an emergency overcurrent trip is generated **"EME.Trp" (Fno. 2141)**, if I_1 remains higher than the setting in **"14 I1>EME"**.

The tripping time can be delayed by the parameter **"14 T I1"**. That allows during an external fault other differential protection relays to clear the fault, before the relays in the "Emergency overcurrent mode" trip the breakers of there line.

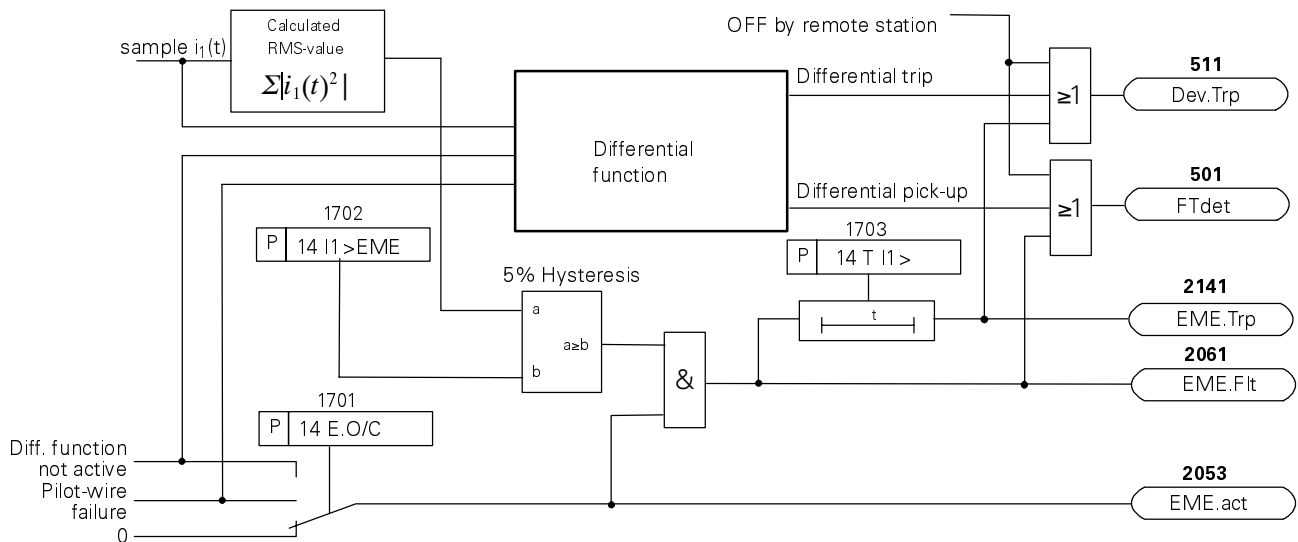

Figure 4.10 Logical diagram of the emergency overcurrent function

4.6 Additional functions

The 7SD600 has the following additional functions

- Processing of events,
- Disturbance recording,
- Measurement of operational values,
- Monitoring functions.

4.6.1 Processing of events

After a fault in the power system, information regarding the reaction of the protection and the measured signals is required for a close analysis of the nature of the system fault. For this purpose, the device can process the events in three distinct manners.

4.6.1.1 Display and binary outputs (signal relay)

Important events and states are shown via optical displays (LED) on the front panel. Over and above this, the device contains signal relays for indication. Signal relays, trip relays and displays can be marshalled, i.e. the factory settings can be changed. In section 5.5 the factory pre-settings and marshalling options are discussed. Signal relay SR1 has a fixed marshalling "Protection ready".

The signal relays are not memorized and are reset once the initiating condition drops off. The LEDs can be operated in the memorized or non-memorized state (settable).

The display memories can be reset

- locally, by pressing the reset pushbutton on the device (key "N"),
- remotely via a binary input for remote resetting,
- via the operator interface, with the PC program DIGSI
- automatically at the beginning of each new fault detection.

Some displays and relays signal states; these should not be stored. They can also not be reset until the criterion to be signaled has been canceled. This parti-

cularly applies to failure indications such as "Failure - pilot wire monitoring" etc.

A green LED indicates the healthy state ("Operation"). It cannot be reset and lights up when the microprocessor is fully functional and no device faults have been signaled. It extinguishes when the self-checking function of the microprocessor recognizes a fault or no auxiliary supply voltage is available.

If the auxiliary supply voltage is available but there is an internal device fault, the red LED lights up ("Fault"); the device is blocked.

4.6.1.2 Information via display panel or PC

Events and states are indicated in the display panel on the front of the device. The information can also be transmitted to, e.g. a PC, connected to the operator interface. The interface also permits transmission of data via a modem connection.

In a rest state, i.e. as long as there are no system faults, the display panel shows the operational measured values of the currents I_1 and $I_{D\text{diff}}$ (I_D). In the event of a system fault, information on the fault will be displayed instead. The first display line contains starting indications and the second line shows trip indications of the differential protection. As soon as these fault events are acknowledged, the rest state information is displayed again. Acknowledgement is identical to resetting the memorized LED displays as described in section 4.6.1.1.

The device also has several event buffers, e.g. for operational events, (see section 6.4). If the auxiliary supply voltage fails, the event buffers are cleared.

The operational events, and all available operational measured values, can be transferred to the display panel at any time via the operator keypad or transferred to the PC via the operator interface.

After a system fault, for example, important information on its characteristic can be read out, such as starting and tripping. The start of the fault is tagged with the real time of the internal system clock. The course of the fault is indicated with relative time, which is referenced to the instant of fault detection, allowing

the duration up to tripping and resetting of the trip command to be recognized. The resolution of the real time is 1 ms.

Using the PC and the protection data processing program DIGSI®, events can also be read out, thus offering convenient screen visualization and menu-assisted operation. The data can be either printed out or stored in a file.

The protection device stores the events of maximum the previous eight system faults; in the event of a ninth fault, the oldest event in the fault memory is deleted and overwritten.

A system fault starts with the protection function fault pick-up, and ends with the fault detector reset of the last fault. A system fault can also comprise more than one incident (from fault detection pick-up to fault detection drop-off).

4.6.2 Disturbance recording

The instantaneous values of measured or calculated signals

$$i_1, i_{Diff}, i_{Stab}$$

are sampled at an interval of 1.66 ms (at 50 Hz) or 1.38 ms (at 60 Hz) and stored in a cyclic buffer. In the event of a fault, the data is stored for a settable period, but maximally 5 seconds. Up to 8 fault records can be stored. The fault record memory is automatically updated in the event of a new incident, so that acknowledgement is not necessary. If the auxiliary supply voltage fails, the fault record memory is cleared.

Data can be read from a PC via the operator interface and processed using the protection data processing program DIGSI®. Graphical representation of the currents is possible. In addition, signals are logged as binary markers (tags), e.g. "starting" and "tripping".

4.6.3 Measurement of operational values

The r.m.s. values of the currents I_1 , I_2 , I_D , I_R are permanently available and may be retrieved as long as there is no trip pending.

I_1 - Local current (measured)

I_2 - Calculated remote current

I_D - Diff. current (calculated)

I_R - Restraint / Stabilization current (calculated)

4.6.4 State interrogation

7SD600 allows the interrogation of the switching states of all binary inputs and outputs. The start of the interrogation is initiated from the operator keypad or via the operator interface.

Following the start of the state interrogation, the current switching states of all binary inputs, all signal and command relays and all LEDs can be displayed consecutively.

4.6.5 Monitoring functions

7SD600 is equipped with comprehensive monitoring functions which cover device hardware as well as software.

4.6.5.1 Hardware monitoring

The device is monitored from measurement inputs through to the command relays. Monitoring circuits and processor check the hardware for faults and non-permissible conditions. These include the following

- Auxiliary and reference voltages:
 - Power failure or disconnection of the supply voltage shuts down the device; an indication may be issued by means of the idle state of a suitably marshalled relay. Short-time interruptions (<50 ms) of the auxiliary supply voltage do not influence the operation of the device (for nominal auxiliary supply voltage ≥ 110 V).

- Command relay circuits

The command relays for operation of the trip and and close coils of the circuit-breaker are switched with two command channels and an additional release channel. As long as there is no start pending, the processor cyclically checks that each channel is functioning correctly by switching each one individually and checking its response. In the event that the check reveals a fault in a channel or a fault in the command relay coil, the command output is immediately blocked and an alarm issued.

- Memory chips

During device startup (i.e. after the auxiliary supply voltage has been applied) a data pattern is written into the working memory (RAM) read out again and compared.

The remaining memory chips are checked periodically for faults by

- generating a check sum for the program memory (EPROM) and comparing with the stored check sum,
- generating a check sum for the parameter memory (EEPROM) and comparing with the newly determined check sum generated with each parameterization process.

4.6.5.2 Software monitoring

For continuous monitoring of the sequence of program execution, a time monitor (watchdog) is provided. If the processor fails, or the program sequence is disrupted, the watchdog timer expires and resets the processor. Further internal plausibility checks during the program execution ensure that any faults are detected, thus initiating a reset and restart of the processor.

In the event that a fault is not eliminated by the restart, another restart is attempted. After three unsuccessful restarts, the protection shuts down autonomously and the red "Fault" LED lights up. The device ready relay (if marshalled) drops off and signals "Device failed" with its normally closed contact.

5 Preparation Instructions



Warning

In order to ensure the trouble-free and safe operation of this device, it must be properly transported and correctly stored, assembled, operated and maintained in compliance with the warnings and instructions in the system manual.

Please note in particular the General Installation and Safety Regulations for Working on Electrical Power Installations (e.g. DIN VDE). Noncompliance may cause death, personal injury or considerable material damage.

5.1 Packing and unpacking the device

The devices are factory-packed to comply with the requirements set out in IEC 60255-21.

The device is to be unpacked with due care, using suitable tools and without employing unnecessary force. Carry out an immediate visual check of the devices to ensure that there is no physical damage.

The transport packaging can be used again if the device has to be transported again. The storage packaging of the individual devices is not suited for transport.

If using any other packaging, it must be ensured that this complies with the shock stress requirements as set out in IEC 60255-21-1 Class 2 and IEC 60255-21-2 Class 1.

Before connecting the device to the power supply for the first time, it should be left to stand in the operating area for at least two hours in order to allow the temperature to adjust and to prevent humidity and moisture condensation.

5.2 Preparing for operation

Please observe the operation requirements as set out in VDE 0100/ 5.73 and VDE 0105 Part 1/7.83.



Caution

The modules of digital protection equipment contain CMOS circuits. Never remove or plug in individual modules when live. Always handle modules in such a manner that there is no risk of damage as a result of static discharges. Always observe the ESD regulations (for **E**lectrostatic **S**ensitive **D**evelopments) when handling individual modules.

There is no risk when the devices are already installed.

5.2.1 Assembly and connection

5.2.1.1 Models 7SD600*-*B*** and -*D*** for panel surface mounting

- Secure the device to the control panel with 4 screws. In the case of model -*B***, ensure that it has sufficient spacing to the adjacent devices. For dimensioned drawing, see Figure 2.1 (on page 2 - 2).
- Affix sturdy, low-resistance and low-inductance system earthing to the bottom earthing surface with at least one M4 screw. Earthing strips to DIN 72333 Form A, e.g. order no. 15284 from the company Druseidt in Remscheid, Germany are suited for this purpose.
- When establishing the connections via the screw terminals, observe the designation of the individual connections, the permissible cross-sections and stud torques (see section 2.2). Only use copper wires!
- The shield of the serial RS485 interface must be earthed.

5.2.1.2 Model 7SD600*-*E*** for panel flush mounting or cubicle mounting

- Push the top and bottom covers of the front cover back to gain access to four slots located in the bracket.
- Push the device into the control panel cutout or cabinet frame and secure with the four fastening screws. For dimensioned drawing, see Figure 2.3 (on page 2 - 4).
- Affix sturdy, low-resistance and low-inductance system earthing to the rear earthing surface with one of the two M4 screws. Earthing strips to DIN72333 Form A, e.g. order no. 15284 from the company Druseidt in Remscheid, Germany are suited for this purpose.
- Establish connections using the plug-in or screw terminals of the connector module on the housing. Always observe the designation of the individual connections, the permissible cross-sections and stud torques (see section 2.2). Only use copper wires! Where possible, screw terminals should be used; the plug-in terminals require special tools and can only be used for the system wiring if a reliable strain relief is installed.
- The shield of the serial RS485 interface must be earthed (if used).

5.2.2 Checking the specified ratings

It must be checked that the specified ratings of the device match the system data. This particularly applies to the nominal auxiliary supply voltage and the nominal currents of summation transformer 4AM4930.

5.2.2.1 Auxiliary supply

The auxiliary supply voltage has three input voltage ranges (see section 2.3 and chapter 3). If, in exceptional cases, the rated device supply must be changed to match the station requirements, it must be noted that the models for 60/110/125 V- and 220/250 V- are interchangeable by means of adjustment with pluggable links. The allocation of these pluggable links to the nominal voltage ranges, as well as their physical arrangement on the p.c.b., is shown in Figure 5.1. The 220/250-V model is also suited for the supply of 115 V a.c. voltage. On delivery of the device all the pluggable links are correctly set in accordance with the specifications on the rating plate and do not need to be changed.

5.2.2.2 Control voltage for binary input

On delivery, the binary inputs are set so that the DC-voltages in the entire operating range of 17 V to 288 V can be used to control the binary inputs. In the case of large station control voltages (≥ 110 V-), it may be sensible to increase the pick-up threshold of the binary inputs, to allow for an increased static margin against interference signals. This prevents the possibility of an erroneous response as a result of any existing interference voltages such as, e.g. earth fault monitoring equipment working in parallel.

In order to equip a binary input with an increased operating point of approx. 74 V, the respective pluggable

links must be changed. The allocation of these pluggable links to the binary inputs and their physical arrangement is shown in Figure 5.2.

- Push the top and bottom covers of the front hood back; underneath each cover, you will have access to a central screw. Loosen both screws.
- Pull the module out by the front cover and place it on a surface suitable for electrostatic sensitive devices (ESD);
- Secure the device to the control panel with 4 screws. For dimensioned drawing, see Figure 2.3.



Caution

Electrostatic discharges via the terminals of the module, p.c.b.s and pluggable links must be avoided by first making physical contact with earthed metal parts.

- Check pluggable links in accordance with Figures 5.1 and 5.2;
- Insert module in the housing;
- Secure the module in the housing by tightening both screws.
- Replace covers.

5

Preparation Instructions

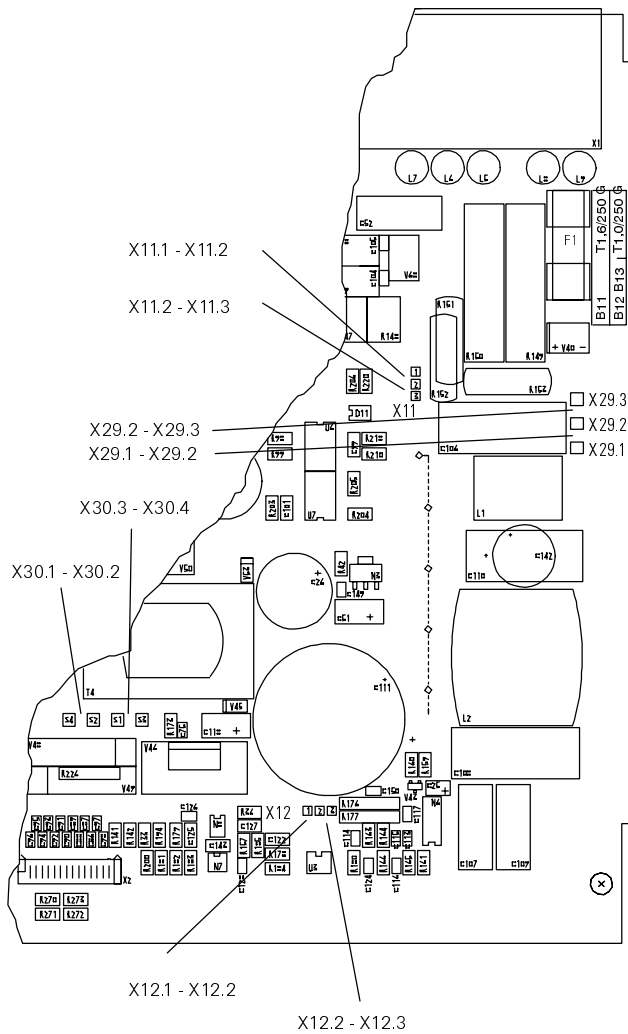

Pluggable links	Auxiliary nominal voltage	
	60 V - 110 V - 125 V -	220 V - 250 V - 115 V ~
X11.1 - X11.2	X	
X11.2 - X11.3		X
X12.1 - X12.2		X
X12.2 - X12.3	X	
X30.2 - X30.1	X	
X30.2 - X30.3		X
X30.3 - X30.4	X	
X29.1 - X29.2		X
X29.2 - X29.3	X	

Figure 5.1 Check set nominal voltage of the integrated power supply

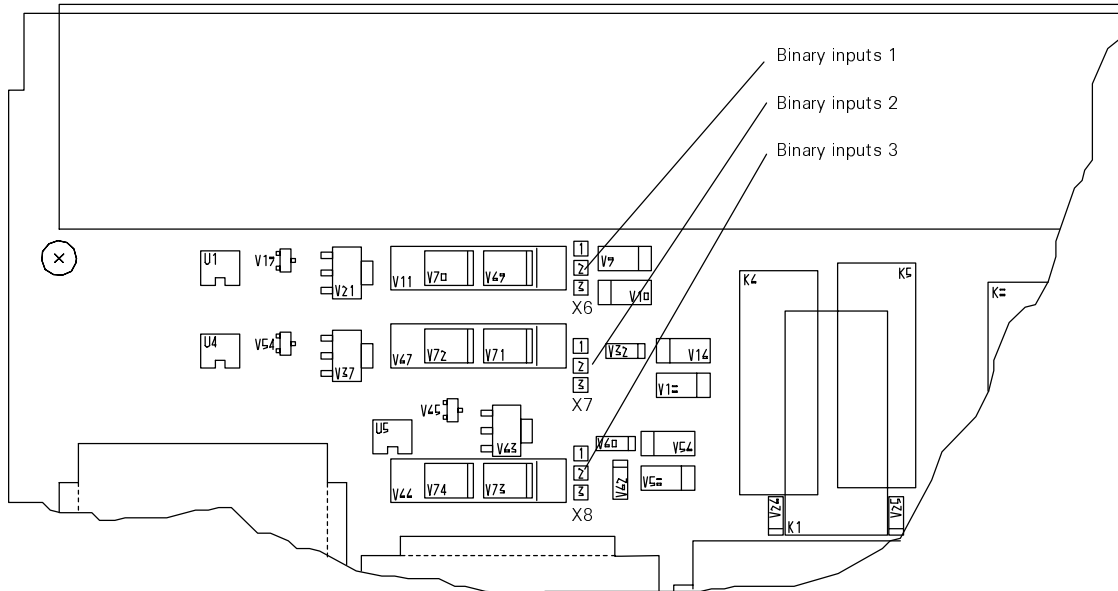

Nominal voltages 24/48/60 V:- The pluggable links X*2 - X*3 must be inserted! (Operating point approx. 17 V-)
 Nominal voltages 110/125/220/250 V:- The pluggable links X*1 - X*2 can be inserted. (Operating point approx. 70 V-) with * = 6, 7 and 8

Figure 5.2 Check of selected control voltages of binary inputs 1 to 3 on the p.c.b.

5.2.3 Checking the connections



Warning

Some of the following check steps involve exposure to dangerous voltages. All checks must therefore be carried out by competent persons in accordance with the relevant safety requirements and precautions.

Before connecting the device to the power supply for the first time, it should be left to stand in the operating area for at least two hours in order to allow the temperature to adjust and to prevent humidity and moisture condensation.

- The circuit-breaker of the DC-voltage supply must be switched off.
- The CT-connection must be checked in accordance with the plant and connection diagram:
 - Is the current transformer correctly earthed?
 - Correct phase allocation of the current transformer?
 - Uniform polarity of the current transformer terminations?
- Loop the DC-amp-meter into the auxiliary supply voltage supply line; range approx. 1.5 to 3 A.
- Switch on mcb for battery voltage (supply protection). The power consumption must correspond (after a short pointer swing due to the charging current rush of the storage capacitors) to the nominal no-load power consumption (approx. 2 W).
- Switch off mcb for direct supply voltage.
- Remove DC-amp-meter; re-establish normal auxiliary supply voltage connection.
- Switch on circuit-breaker of the DC-voltage supply. After maximum 0.5 seconds, the green LED in the front panel must light up and the red "fault" indication must extinguish after max. 7 seconds.

- Switch off mcb for direct supply voltage.
- Check trip wires to the circuit-breaker.
- Check control wires to and from other devices.
- Check signaling wires.
- Switch mcb back on

5.2.4 Connection circuits

The connection circuit (standard connection) is represented in the appendix A.1 . The three input windings of the summation transformer permit connection to the current transformer in a number of different ways; The most common types of connection are described below. It is imperative, however, that the connection type is the same at both line ends. The marshalling options for the binary inputs and outputs are described in section 5.5.

5.2.4.1 Standard connection L1-L3-E

The standard connection is suitable for all systems, irrespective of the earthing of the system's neutral point. Figure 5.3 shows the current transformer connections. In comparison to the symmetrical three-phase current, the sensitivity for Ph-Ph short-circuits varies with a factor between 0.58 and 1.15, and those for earth faults or double earth faults are more sensitive with a factor of 1.73 to 2.89. In isolated-neutral or resonant-earthed systems, the phases can also be changed cyclically or acyclically in order to adjust the device to the double earth fault preference which prevails in the system. To this end, the preferred phase is connected to the first winding with the factor 2 while the non-preferred phase is not directly connected to the device.

The connection circuit shown in Figure 5.3 therefore corresponds to the double earth fault preference L1 before L3 before L2. In an electrically connected system, the connection type must be the same at both ends of the line.

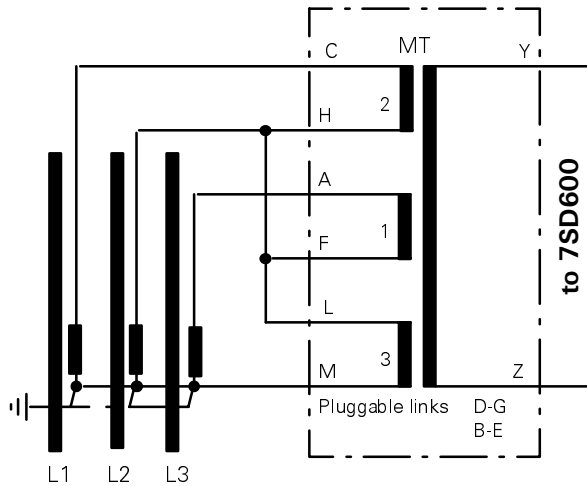

Figure 5.3 Standard connection L1-L3-E

5.2.4.2 Connection for reduced earth-fault sensitivity L1-L2-L3

In earthed systems with particularly low zero sequence impedance, the fault current for a single-phase earth fault may be greater than the fault current for a two-phase short-circuit. In such cases, taking into account the thermal stress of the measuring circuit, the current transformer is connected as shown in Figure 5.4. The sensitivity compared to the symmetric three-phase current is between 0.58 and 1.73 for all types of short-circuits.

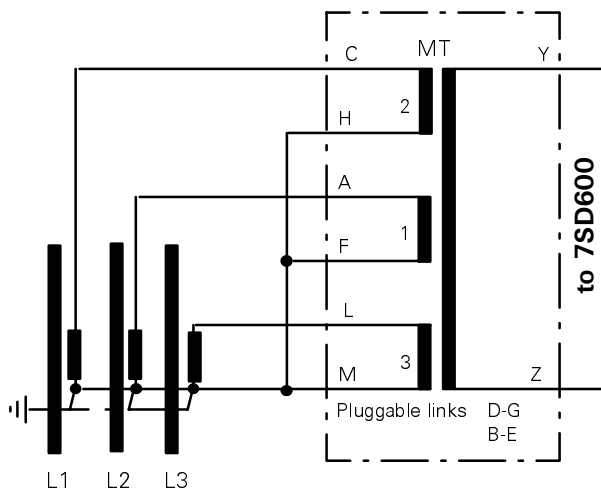

Figure 5.4 Connection L1-L2-L3 with reduced earth-fault sensitivity

5.2.4.3 Connection for increased earth-fault sensitivity L1-L3-E

If the sensitivity to single-phase earth faults must be higher than that achieved with the standard connection, for instance in systems with low resistance earthed star points, this may be partially achieved by connection of a matching transformer MT, as shown in Figure 5.5. Considering the loading of the current transformer, this circuit can be used to approximately double the current in the neutral conductor. The earth fault sensitivity is increased to a factor in the range of 3.46 to 5.77 in relation to the symmetrical three-phase current. In the case of Ph-Ph short-circuits, the same sensitivity applies as for a standard connection.

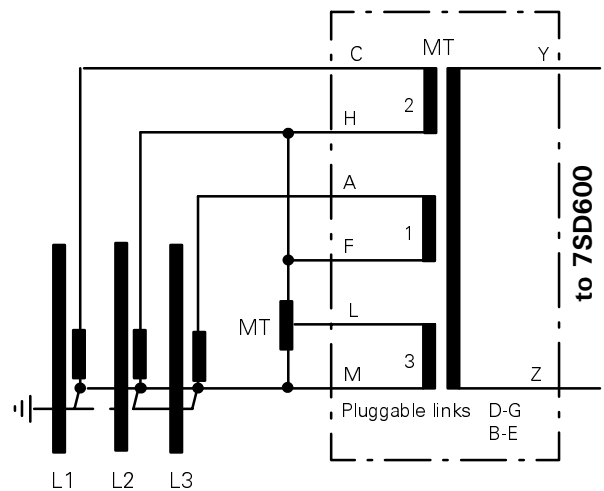

Figure 5.5 Connection L1-L3-E with increased earth-fault sensitivity

5

Preparation Instructions

5.2.4.4 Different primary nominal currents

If the current transformers of the two line ends have different primary nominal currents, the currents need to be matched via the matching transformer. Matching is carried out at the line end with the lower primary nominal current.

As current inputs are galvanically isolated in the 4AM4930, the matching transformers can be inserted in an auto-transformer mode. This makes better use of the rating of the matching transformer and enables implementation of a lower-rating type, such as the 4AM51 70-7AA. Figure 5.6 shows a sample connection.

The actual transformation ratio of the matching transformer is determined as follows:

$$r_{\text{minimum}} = \text{minimum} \frac{I_{N \text{ primary}} \text{ for higher rated current}}{I_{N \text{ primary}} \text{ for lower rated current}}$$

This means that the turn ratio is

$$\frac{N_1}{N_2} \text{ minimum} = \text{minimum} \frac{I_{N \text{ primary}} \text{ for lower rated current}}{I_{N \text{ primary}} \text{ for higher rated current}}$$

with

N_1 - relative number of turns of the side facing the main current transformer,

N_2 - relative number of turns of the side facing the summation transformer.

Example:

Current transformer at line end I: 500 A/1 A

Current transformer at line end II: 400 A/1 A

Matching is carried out at line end II:

$$\frac{N_1}{N_2} = \frac{I_{N \text{ primary}} \text{ for lower rated current}}{I_{N \text{ primary}} \text{ for higher rated current}}$$

$$\frac{N_1}{N_2} = \frac{400 \text{ A}}{500 \text{ A}} = 0,8 \text{ corresponds to e.g. } 40/50 \text{ turns}$$

If the earth-fault sensitivity is to be increased in accordance with section 5.2.4.3, the matching transformer inserted in the earth current path, as shown in Figure 5.6, can also be used for this purpose.

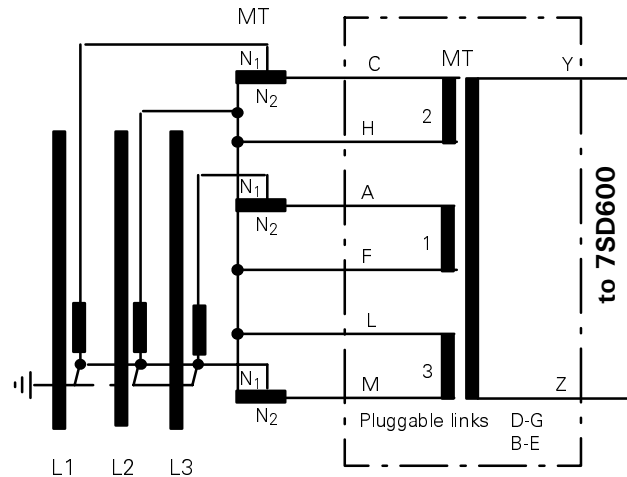

Figure 5.6 Matching unequal primary currents

5.2.4.5 Two-phase connection

If a system without an earthed neutral only has two current transformers, the phase on the device without a current transformer remains free (Figure 5.7). In the case of a double earth fault, the fault is not detected by the protection. This must conform to the double earth fault preference in the whole of the electrically connected system. Please note that the same phase must also be free at the other line end, even if it is fitted with three current transformers.

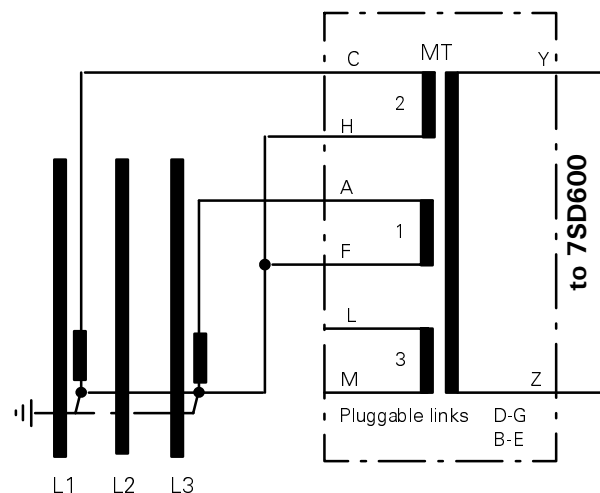

Figure 5.7 Two-phase connection L1-L3

5.2.4.6 Connection of the pilot wires

In case of equal current transformer polarity at both line ends, the pilot wires are connected crossed over to the terminals (see figure 4.8). In case of unequal current transformer polarity at both line ends, it is necessary to connect the pilot wires 1:1. That means to connect the terminals with equal terminal number at both ends.

5.2.5 Demands on the current transformer

Very large short-circuit currents flowing through the protected zone in particular may cause larger transformation errors due to the current transformers saturating. Due to the stabilization of the differential protection, differences

in the transformation by the current transformers can to a large degree be tolerated by the differential current measurement. Nevertheless, the current transformers must have a minimum degree of conformity at the largest short-circuit arising in the application.

If the differential protection is connected to linearized current transformers at both line ends, it is essential to ensure that the overall connected load is not greater than the rated burden of the transformer. If a closed iron core transformer is connected, it is necessary to determine the operational accuracy limit factors in order to check that there is sufficient conformity at the highest fault currents. The values specified on the rating plate for the accuracy limit factor n are minimum values.

The operational accuracy limit factor n' can be calculated from the data of the current transformer and the connected load using the following equation:

$$n' = n \cdot \frac{P_N + P_E}{P_W + P_E}$$

whereby:

- n' = Operational accuracy limit factor
- n = Accuracy limiting factor
- P_N = Rated burden of the current transformer
- P_E = Internal burden of the current transformer
- P_W = Connected burden

The internal burden P_E is not specified on the rating plate of the current transformer. It can be determined

by measuring the resistance of the secondary winding. The internal burden cannot be calculated from the rated burden. Current transformers with rated burden equal to or greater than the connected burden and with a sufficiently large accuracy limiting factor should be used for the 7SD600.

Implementation of sets of transformers with widely varying limiting factors is not permitted, e.g. a linearized transformer at one end of a line and a closed iron core transformer at the other end.

The line differential protection 7SD600 makes the following demands on the current transformer:

1. The current transformers may not saturate due to the maximum steady-state through fault current:

$$n' \geq \frac{I_{kd \max}}{I_{Npr}}$$

$I_{kd \max}$ = Maximum steady-state through fault current

I_{Npr} = Primary rated current of the current transformer

2. Any deviation of current transformer data (operational accuracy limit factors) at both ends must be within the following range (assuming the same primary currents):

$$3/4 \leq n_1' / n_2' \leq 4/3$$

For detailed determination of current transformer requirements, see appendix A.4.

5.2.6 Demands on the pilot wires

The measuring principle of the 7SD600 requires a symmetrical pilot wire pair between the two stations. The rated voltage must correspond to the voltages that may be induced by faults. It must be at least 500 V. The symmetry of the pilot wires must comply with Post Office requirements for telephone operation (symmetrical wire/wire at 800 Hz: 10^{-3}).

Pilot wires as cable connections must always be checked for high-voltage interference. The wires of the protection cable must be able to cope, not only with the load of the currents to be transmitted and their fault-induced voltage peaks, but also with any external stresses.

5

Preparation Instructions

The greatest electrical danger for pilot wires cables occurs in high-voltage systems during a short-circuit with earthing. The fault current induces a longitudinal voltage in the pilot wires running parallel to the high-voltage line.

The induced voltage in the pilot wires can be prevented by using highly conductive cable sheaths and special armor (minimum possible reduction factor for both high-voltage cables and protective cable). In addition, the lines can be isolated via transformers, which serves to sectionalize the longitudinal voltage.

The induced voltage can be calculated using the following formula:

$$U_l = 2 \pi f \cdot M \cdot I_{k1} \cdot l \cdot r_1 \cdot r_2$$

with

U_l = Induced longitudinal voltage in V,

f = Nominal frequency in Hz,

M = Mutual inductance between power lines and pilot wire in mH/km,

I_{k1} = Maximum single-phase fault current in kA,

l = Length of parallel section between power lines and pilot wires in km,

r_1 = Reduction factor of power cable (1 for overhead lines),

r_2 = Reduction factor of pilot wire cable.

Only half of the calculated induced voltage needs to be taken into account as it builds up at both ends of the isolated-neutral pilot wires.

The external electric circuits of the 7SD600 are designed for 2 kV rated voltage. Pilot wires with max. 2 kV rated voltage can therefore be directly connected.



Warning

The longitudinal voltage in the pilot wires (induced by the earth-fault current) must not exceed a max. 60 % of the rated voltage.

This means that if 1.2 kV is exceeded, the devices must be electrically isolated from the pilot wires by isolating transformers. The rated voltage of the pilot wires may make a further sectionalization necessary. Even if isolating transformers are used, the voltage must not exceed either 60 % of the rated voltage of the isolating transformer or 60 % of the rated voltage of the pilot wire!

This isolation up to 5 kV can be achieved using the isolating transformer 7XR9514, up to 20 kV using the isolating transformer 7XR9513 (Figure 5.8). The center tap T1 on the side facing the relay must be earthed to eliminate the risk of electrical shocks. On the pilot wire side, the center tap T2 must not be earthed.



Caution

The pilot wires must not be earthed or fitted with surge arrestors.

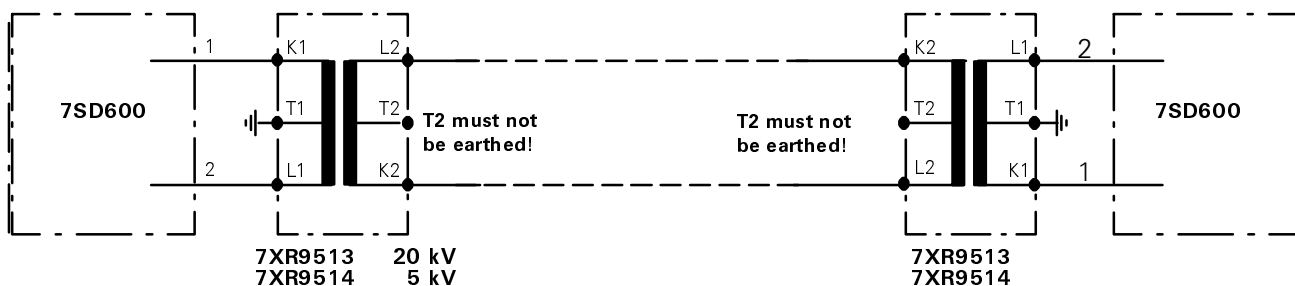

Figure 5.8 Connection of isolating transformer 7XR9513 or 7XR9514

5.3 Setting the operator and memory functions

5.3.1 Operating conditions and general information

Most of the operator functions require input of a "code word". This is a preset key sequence which must be input before entries via the operator keypad or system interface, which relate to the protection functions of the device, such as

- Configuration parameters for operating language, interface and device configuration,
- Marshalling of trip relays, indications, binary inputs and LEDs,
- Setting of function parameters (threshold values, functions),
- Triggering of test sequences.

As proof of identification and as security against inadvertent changes, input of a code word is necessary.

In the menu items which require a code word, the device is informed of the intended presetting alteration by pressing either the "+" or "-" key. "CW:" then appears on the display to prompt input of the code word. **The code "word" itself consists of the key sequence "- + -".** These keys must be pressed in the indicated sequence and confirmed with **E**. If the code word has been entered correctly the display shows "CW OK_".

By pressing the **E** key again the display returns to its original state, this time with the last character underlined, which indicates that the device is now ready for alteration input. Use the "+" or "-" key to change the preset text or numerical value. A flashing cursor appears with the first alteration and indicates that the device is now operating in "Change Settings" mode until the new value is accepted by pressing the enter key **E**. The Change Settings mode is also ended when you quit the setting level or when the monitoring time has expired.

```
C W :
@ @ @
```

```
C W O K _
```

```
C W W R O N G
```

The characters entered are not shown on the display. Instead, an @ is displayed. As soon as the input is confirmed by pressing E, CW OK_ is displayed if the code word was correct. Continue with **E**.

CW WRONG is displayed if the input was wrong. Press the + or - key repeatedly to enter a new code word.

5

Preparation Instructions

The operator interface comprises a hierarchically structured menu tree which can be navigated using the scrolling keys ◀; ▶; ▲ and ▼, thus providing access to each operating object. A complete overview can be found in appendix C. Figure 5.9 shows the steps required to reach configuration.

If the device is ready to run and in its initial state, start by pressing the ▼ key: "Parameter settings" (PARAME.), the first main menu item in the first operating

level of the menu tree appears. Pressing ▶ leads to the 2nd level starting with the programming block (00 CONF.). Repeated pressing of the ▼ key takes you through the tree up to block 95. The ▲ and ◀ keys take you to the previous block or previous operating level.

Next to the block number, the heading of the block "Integrated operation" is shown in abbreviated form (INT. OP):

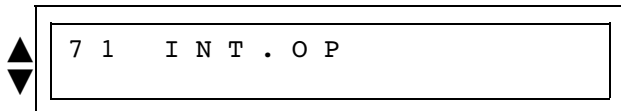

[7100]

Beginning of the configuration block "Integrated Operation"

Address blocks 71 to 74 are provided for the configuration of the range of functions. This is where all settings are carried out which deal with the operation of the device, communication with external operating and evaluation devices via the serial interface and fault value storage.

As an alternative to local operation, the device can also be set with the protection operating program

DIGSI 3 via the serial interface. This requires a converter that carries out conversion from the RS485 interface on the device to the RS232 interface.

For this device see "order data" in chapter 2.3 under "Accessories".

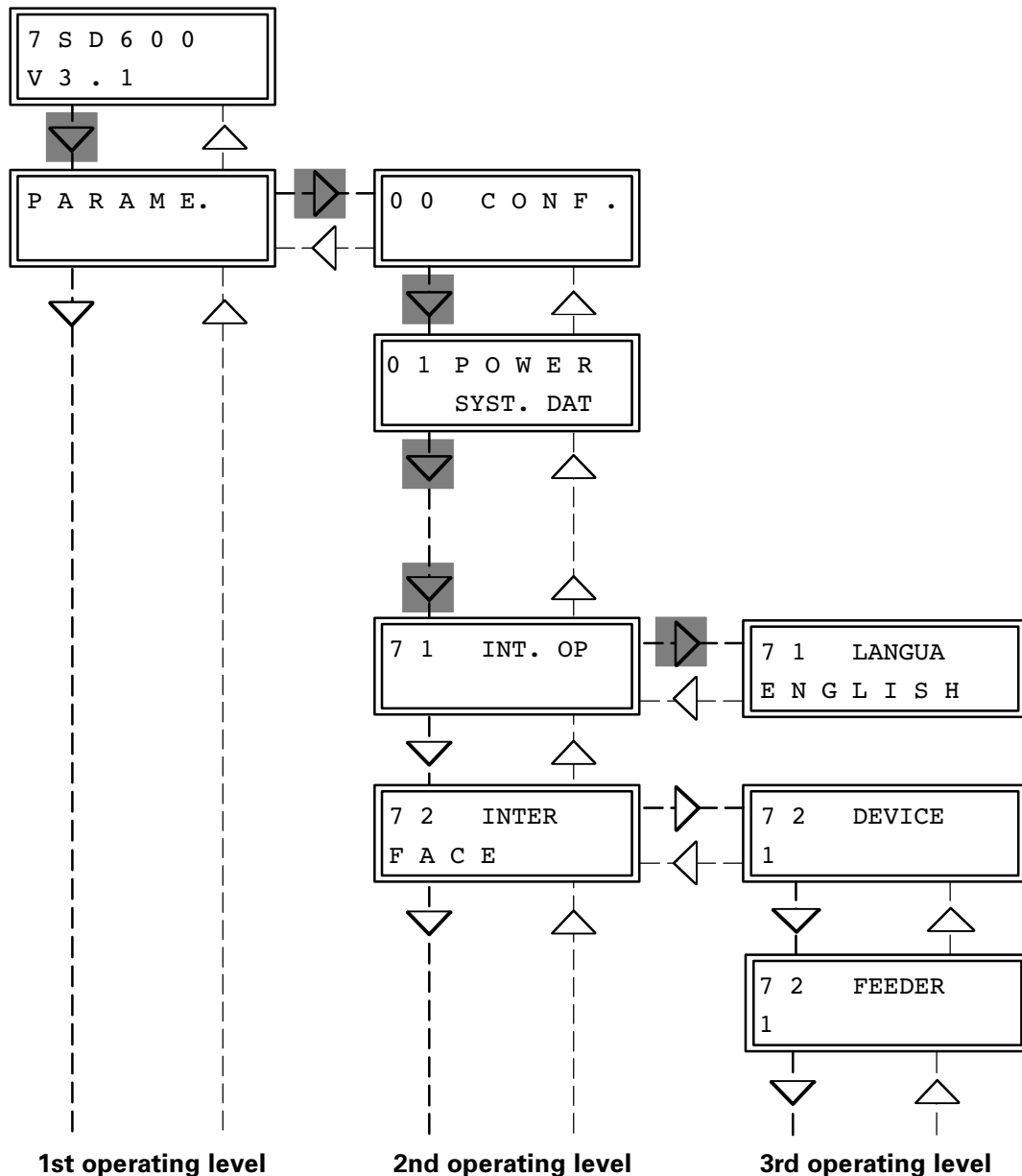

Figure 5.9 Excerpt from the menu tree: Selection of configuration blocks

Press the ► key to switch to the 3rd level and the first configuration block. From here, you can return to the 2nd operating level with the ◀ key and from there with the ▼ key to the next operating block **72**, etc.

The display shows the 2-digit block number and the significance of the requested parameter (see Figure

5.9). The second display line shows the text or value of the parameter. Use the "+" or "-" key to change the preset text or numerical value. If operation is carried out via a PC and the operating program DIGSI[®], each setting parameter is identified by a 4-digit address number.

5

Preparation Instructions

In the following Figures this is shown in brackets next to the explanations.

For text parameters the next text then appears which is entered in the box attached to the display box, etc. The selected alternative **is confirmed by pressing the enter key E**. When the last possible alternative has been reached using the "+" key, any further pressing of the key will have no effect. This also applies when the first alternative is reached using the "-" key.

Settings which require a numerical value can be changed, starting from the preset value, using the "+" key (for a higher value) or the "-" key (for a lower value) and confirmed with the **E** key. Continuous pressing of the "+" or "-" key acts as a repeat key function, simulating repeated entries. The longer the key is pressed, the faster the pace of the repeated key strokes. In this manner, settings across a large setting range can be carried out rapidly and conveniently with a small setting step.

If you attempt to scroll forward to another operating object or page to another operating level using the arrow keys without first confirming an alteration with the **E** key, the following prompt appears: "Change parameter?". Confirm with the "Yes" key **Y/J** to ap-

ply the new setting. The new value or text is shown. However, if you press the "No" key **N**, the change entered since the **E** key was last pressed is canceled and the old value or text is displayed. This enables you to cancel any erroneous changes. To continue to scroll forward, you must now press the relevant arrow key again.

When the configuration of a configuration parameter is terminated by pressing the enter key **E**, the associated data are permanently saved and protected against power failure in EEPROMs.

5.3.2 Settings for integrated operation - block 71

Block **71** allows you to change the operating language.

On delivery of the device, the display outputs instructions and designations in English. From block 71 (see above) you can switch to the ▸ 3rd operating level where the operating language can be changed. The currently available operating languages are shown in the boxes below.

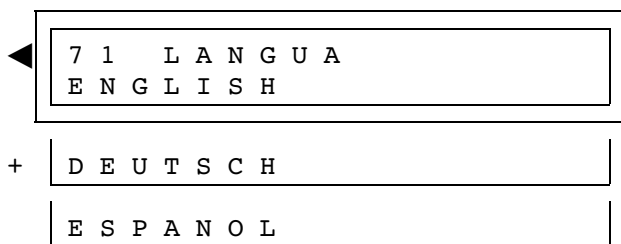

[7101]

The available languages can be called up on screen by repeatedly pressing the + or - key; each language is displayed in its native tongue. The required language is then selected by pressing the enter key **E**.

5.3.3 Settings for the serial interface - block 72

The device is equipped with one serial RS485 interface which enables the connection of several devices in series via an electric bus. An RS485/RS232 converter is required for conversion to a PC interface. Communication via this interface requires certain declarations with regard to device identification, transmission format and transmission speed.

For this purpose, certain settings need to be made in block 72, whereby the code word must be entered (see section 5.3.1). The entered data must match the devices to be connected.

A setting for the serial transmission GAP only needs to be set if the device is required to communicate via modem. The GAP is set to the maximum permissible time duration of the GAP during transmission of a

message. Transmission gaps arise when using modems with data compression, error correction and differences in baud rate. If the transmission quality between modems is good, the setting 1.0 is recommended. In the event of a bad connection, this value needs to be increased. Please note that the GAP setting must be smaller than the value "Response time protective device" in the protection operator software DIGSI® V3. Recommended value:

$$\text{GAP} \approx \frac{\text{"Response time protective device"}}{2}$$

High values for "Response time protective device" slow down communication in the event of transmission errors. If connection is directly to a PC, the GAP can be set to 0.0 s.

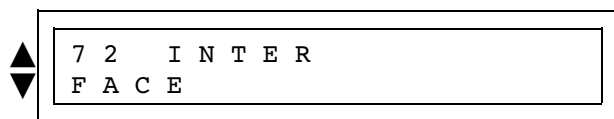

[7200]

Beginning of the "PC interface" block



[7201]

Identification number of the device within the station. The number is arbitrary but must be unique within the substation system.

Lowest setting: 1
Highest setting: 254

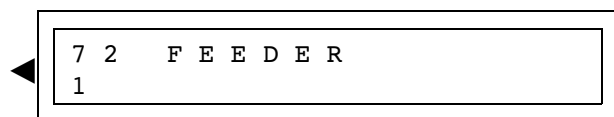

[7202]

Number of the branch within the station (field address).

Lowest setting: 1
Highest setting: 254



[7203]

Identification number of the station, in case more than one station can be operated.

Lowest setting: 1
Highest setting: 254

5 Preparation Instructions

◀ 7 2 F - T Y P E
1 9 2

[7208]

Function type of the device in accordance with IEC 60870-5-103; 192 applies for the differential protection. This address is mainly for information and should not be changed.

◀ 7 2 P C - I N T
D I G S I V 3

[7211]

Data format for the serial interface format for the Siemens protection data processing program *DIGSI*® version V3. (recommended setting for PC operation)

+ A S C I I

ASCII format

V D E W c o m

VDEWIZVEI compatible format (IEC 60870-5-103) for connection to a station control system

◀ 7 2 G A P S
1 . 0 s

[7214]

Maximum message gap permitted during transmission via modem

Lowest setting: 0.0 s

Highest setting: 5.0 s

◀ 7 2 P C B A U D
9 6 0 0 B A

[7215]

The transmission speed for the serial interface can be changed by repeatedly pressing the "+" or "-" key; input is confirmed by pressing the enter key **E**.

+ 1 2 0 0 B D

2 4 0 0 B D

4 8 0 0 B D

◀ 7 2 P A R I T Y
D I G S I V 3

[7216]

Parity of transmission messages can be modified: for *DIGSI*® version V3 with even parity and one stop bit. Also applies to IEC 60870-5-103.

+ 8 O 1

to transmission devices which require *ODD* parity and 1 *STOP* bit

8 N 2

to transmission devices which require *NO* parity and 2 *STOP* bits

8 N 1

to transmission devices which require *NO* parity and 1 *STOP* bit

5.3.4 Settings for fault detection - block 74

The differential protection is equipped with fault data storage (see section 4.6.2). A distinction is made between the reference time and the storage criterion. As a rule, the reference time is the device trip (SRTwitTP) which also serves as the storage criterion. Alternatively, fault detection can also be selected as reference time (see section 4.3.8), whereby the storage criterion can also be the fault detection (RECbyFT) or the device trip command (RECbyTP).

A fault begins with the tripping by the differential protection function or the remote tripping and ends with

the drop off of the last fault detection. For the 7SD600 this is also the extent of a fault record.

The actual recording time begins with pre-fault time T-PRE before the reference time and ends with the post-fault time T-POS after the recording criterion has disappeared. The maximum permissible overall recording time per fault record is set as T-MAX. Overall, a total of maximum 5 s is available for fault recording. This period allows for recording of up to 8 fault records.

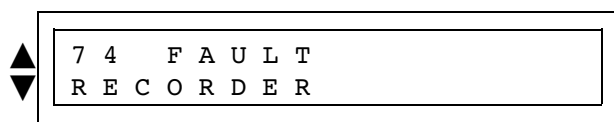

[7400]
Beginning of "Fault recorder" block

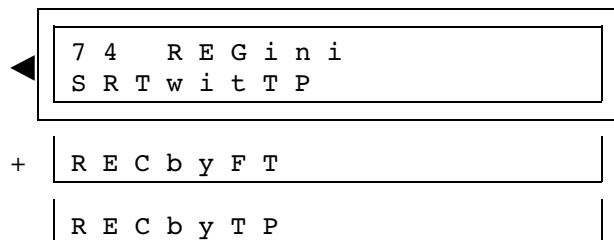

[7402]
Fault data recording is activated:

- Trip command as reference time and trip command as recording criterion
- General fault detection as reference time and general fault detection as recording criterion
- General fault detection as reference time and trip command as recording criterion

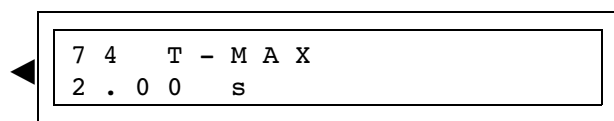

[7410]
Maximum time available for fault value recording

Lowest setting: **0.30 s**
Highest setting: **5.00 s**

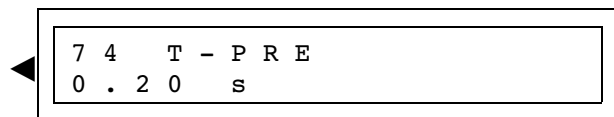

[7411]
Period before starting time (reference time according to the selected event for fault recording activation), at which the fault value recording should begin

Lowest setting: **0.05 s**
Highest setting: **0.50 s**



[7412]
Period after drop off of the recording criterion after which recording of the fault values should end

Lowest setting: **0.05 s**
Highest setting: **0.50 s**

5 Preparation Instructions

5.4 Configuring the protective functions

5.4.1 Introduction

The device 7SD600 provides a range of protective and additional functions, which can be enabled or disabled through configuration such as, e.g. the pilot wire monitoring function.

The configuration parameters are input via the integrated control panel at the front of the device or by means of a PC via the serial operator interface. Handling of the control panel is explained in further detail

in section 6.2. Alterations to the configuration parameters require input of the code word (see section 5.3.1). Without the code word, the settings can be read out but not changed.

The operating block 00 is provided for configuration. This can be reached from the initial state of the device in level 1 by scrolling with the ▼ keys (forwards) and subsequently switching to the 2nd operating level by means of the ► (next level). Block 00 CONFIguration appears (see Figure 5.10).

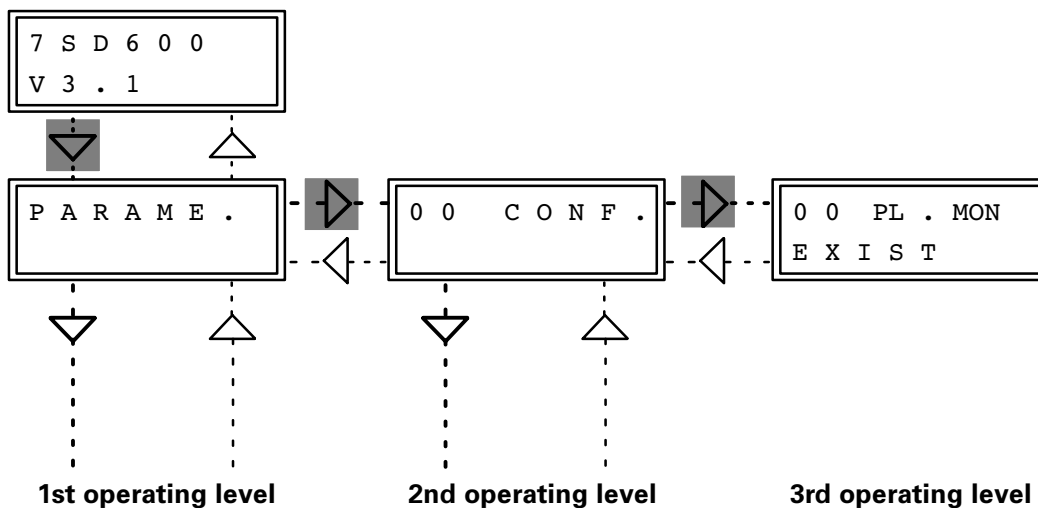

Figure 5.10 Excerpt from the menu tree: Selecting configuration block for the protective functions

Within block 00 you can switch to the 3rd operating level with ► and scroll forward with ▲ or scroll back with ▼. Each additional scrolling action leads to a further operating object for setting a configuration parameter. In the following sections each operating object is shown in a box and explained. The top line of the display panel, behind the block number, shows the device function being configured. The second line contains the associated text (e.g. "EXIST"). If this text is correct, you can use the arrow keys ▼ or ▲ to scroll to the next operating object. If the text needs to be changed, you will need to enter the code word before you can use the "+" or "-" keys to call up an alternative text on the display (e.g. "non EXIST"). There may be several alternatives which can be displayed on the display panel by repeatedly pressing

the "+" or "-" keys. When the last possible alternative has been reached using the "+" key, any further pressing of the key will have no effect. This also applies when the first alternative is reached using the "-" key. The correct alternative can be confirmed by pressing the enter key **E**!

If operation is carried out via a PC using the operating program DIGSI[®], each setting parameter is identified by a 4-digit address number. In the following Figures this is shown in brackets next to the explanations.

If you attempt to scroll on without confirming an alteration with the enter key **E**, the following prompt will appear: "SAVE NEW SETTING ?". Confirm with the "Yes" key **Y/J** to apply the new settings. The new value or text is shown. However, if you press the

“No” key **N**, the change entered since the **E** key was last pressed is canceled and the old value or text is displayed. This enables you to cancel any erroneous changes. To continue to scroll forward, you must now press the relevant arrow key again.

When the setting of a configuration parameter is terminated by pressing the enter key **E**, the associated data are permanently saved and protected against power failure in EEPROMs.

Using the ◀ keys (back one level), you can switch back to the 2nd operating level and move to the next operating block with ▼ (forwards) or, by pressing the ◀ key again, you can switch to the first operating level.

5.4.2 Configuring the functional scope of the device - block 00

The available protective and additional functions can be configured as *EXISTent* or *non EXISTent*. It is even possible to select more than one alternative for some functions.

Functions which have been **configured** as *non EXISTent* will not be processed in the 7SD600. There will be no indications and the associated setting parameters (functions, threshold values) will not be queried during setting (see section 6.3). In contrast, the switching off of a function means that the function will be processed, that indications will be generated (e.g. "... switched off"), but that the function will not affect the overall protection system (e.g. no trip command).

The following boxes show the options for maximum configuration of the device. In practice, functions which are not available will not be displayed.

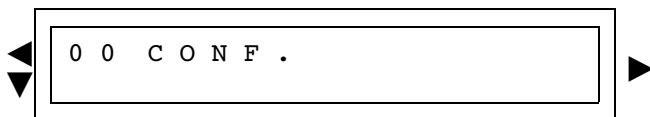

[7800]

Beginning of the block "Configuring functional scope"

Pilot wire monitoring:

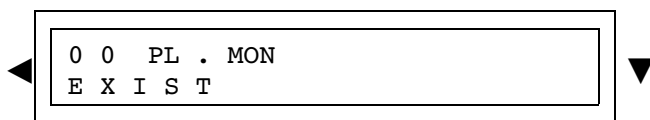

[7816]

available

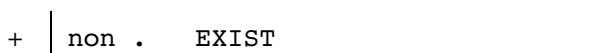

not available

5.5 Marshalling of binary inputs, binary outputs and displays

5.5.1 Introduction

The definition of the binary inputs and outputs shown in the general plans (appendix A) relate to the factory settings of the device on delivery. However, allocation of the inputs and outputs to the relevant functions can be altered and thus adapted to the particular local conditions.

Marshalling of the inputs, outputs and displays is carried out by means of the control panel on the front panel or via the operator interface. Handling of the control panel is explained in further detail in section 6.2. Marshalling begins at block 60.

Marshalling requires input of the code word (see section 5.3.1). Without the code word, the settings can be read out but not changed. A flashing cursor on the display indicates that the device is now in alteration mode, starting with the first alteration after input of the code word and continuing until the end of the marshalling process.

While the programs are running in the 7SD600, specific logical functions arise which are assigned to specific physical inputs and outputs.

Example: A pick up is detected by one of the integrated protective functions. This event is generated in the device as an "indication" (logical function). The indication must be made available at specific device terminals as make contacts. Since specific device terminals are hard-wired to one specific signal relay (physical), e.g. signal relay 2, the device must be informed that the logical indication "FT det" must be sent to signal relay 2. Thus two operator statements are of particular importance during marshalling: Which protection-generated (logical) indication signal should be transmitted to which (physical) signal relay? Several (up to 20) indication signals can be transmitted to a single (physical) signal relay.

A similar situation applies to binary inputs. In this case, external information is transmitted to the device (e.g. "Dif.blk") via a (physical) input module in order to initiate the (logical) function of blocking the I>> differential protection. The relevant question to the operator is therefore: Which signal of a (physical) binary input should trigger which reaction in the protection device? A single binary input can trigger up to 10 (logical) functions.

The command relays of the device can also be marshalled to different functions. Each command relay can be controlled by command functions.

Signal functions can also be used in a variety of ways. For example, a signal function can actuate several signal relays, trip several command relays, as well as be displayed on the LEDs and controlled by binary inputs.

The marshalling process is structured such that each physical input/output module (binary input, signal relay, LED and command relay) will be queried with regard to the assignment of (logical) functions.

The available logical functions are listed in the following sections.

The marshalling parameter blocks are reached by scrolling with the keys ▼ (forwards) or ▲ (backwards), ► (next level) and ◀ (previous level). If the device is ready to run and in its initial state in level 1, you can reach the start of the marshalling blocks as follows (see Figure 5.11):

- Press the ▼ key (forwards),
- use the ► key (next level) to switch to the second operating level,
- scroll with the ▼ key until block 60 appears on the display:

6 0 M A R S H

[6000]

Beginning of the marshalling blocks

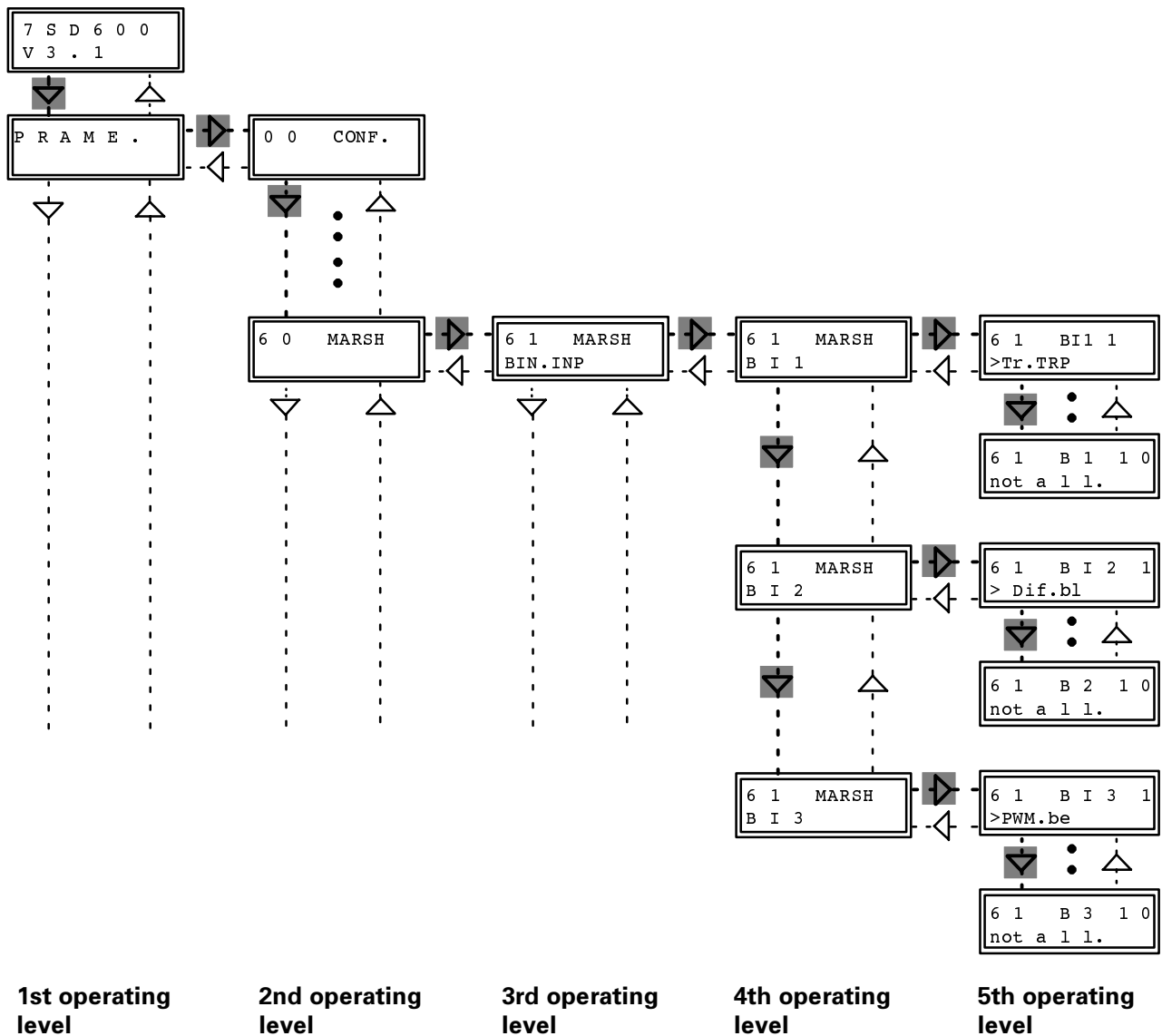

Figure 5.11 Excerpt from the menu tree: Example for selecting marshalling of binary inputs

The **▶** key takes you to the next marshalling block (e.g. 61, marshalling of binary inputs) or the **◀** key takes you back to the 1st operating level (settings). Within a block, you can go to the next level with the **▶** key where you can scroll forwards with the **▼** key and backwards with the **▲** key. Each further scrolling leads to the display and interrogation of an additional input, output or display. The name of the input or output module appears in the display as heading.

Switching to the next level with the **▶** key takes you to the actual selection level for the allocated logical functions. The top line of the display contains the physical input/output module followed by a 1 to 2-digit index number. The 2nd display line contains the currently assigned logical function.

In this 5th level, the **+** key lets you call up all marshallable input/output functions on the display once you have entered the code word. You can also scroll backwards with the **-** key.

The required function is confirmed with the enter key **E**. Additional functions (under further index numbers) can then be selected for the same physical module using the **▼** key. Each selection must be confirmed with the **E** key. If the particular input of a physical module is not assigned, the "not all." function (not allocated) is selected.

To exit the selection level, press **◀**. The previous operating level appears on the display. You can now switch to the next physical input/output module by pressing the **▼** key or to the previous module with the **▲** key where you can then proceed as before.

The following sections specify the marshalling for the binary inputs, binary outputs and displays. The arrow keys **▼▲** or **▶◀** next to the display boxes indicate the method of scrolling from operating level to operating level as well as within the block or selection level. The arrow keys which lead to the next operating object in accordance with the logical sequence of the marshalling process are indicated in bold Figures.

You will find full details of the available function designations in appendix C. If operation is carried out via a PC and the operating program DIGSI[®], each setting parameter is identified by a 4-digit address number. In the following Figures this is shown in brackets next to the explanations.

If you attempt to scroll on without confirming a marshalling with the enter key **E**, the following prompt will appear: "SAVE NEW SETTING?". Confirm with the "Yes" key **J/Y** to confirm and apply the new setting. The new text is displayed. However, if you press the "No" key **N**, the change entered since the **E** key was last pressed is canceled and the old text is displayed. This enables you to cancel any erroneous changes. To continue to scroll forward, you must now press the relevant arrow key again.

When the marshalling is terminated by pressing the enter key **E** the allocations are immediately applied and permanently saved and protected against power failure in EEPROMs.

5.5.2 Marshalling of the binary inputs - block 61

The device has 3 binary inputs which are designated BI 1 to BI 3. They can be marshalled in block 61. You can reach the block from the initial state of the device in level 1 as follows: Press the **▼** key (forwards), switch to the 2nd operating level with the **▶** key (next level), scroll with the **▼** key until block 60 appears on the display. Use the **▶** key to switch to operating level 3 →: Marshalling binary inputs, see Figure 5.11).

Selection is carried out as described in section 5.5.1.

A choice is available for each binary input function as to whether the activated voltage is applied, or whether it is removed, whereby:

- () activated with voltage:
The input acts corresponding to a make contact, i.e. the control voltage at the input terminals activates the function;
- (**N**) activated with voltage reset:
The input acts as a break contact, i.e. the control voltage at the input terminals resets the function. If there is no control voltage, the function is active.

When scrolling with the "+" or "-" key, each input function is displayed either without a status indication (activated with voltage) or with the status indication "N" (activated with voltage reset). The selected function must be confirmed with the enter key **E**.

Table 5.1 shows a list of all the input functions with their respective function numbers Fno. Input functions have no effect if the relevant protective function of the device has been configured so that it is not available (see section 5.4.2).

The general diagrams in appendix A show the assignment of the binary inputs on delivery. The following boxes show an example assignment for binary input 1. Table 5.2 shows all presettings.

6 1 M A R S H
B I

[6100]

Beginning of the block "Marshalling of binary inputs"

Use the **▶** key to go to the first binary input:

6 1 M A R S H
B I 1

[6101]

Assignment of binary inputs 1

Switch to the selection level with the **▶** key:

6 1 B I 1 1
> Dif . bl

[6102]

Blocking differential function input, FNo. 3003 activated with voltage: if input is activated, the diff. function is blocked

6 1 B I 1 2
not a l l.

[6103]

No further functions are activated by input 1.

The "+" key lets you call up all marshallable input functions on the display once you have entered the code word. The "-" key also lets you scroll backwards through the list of alternatives. The required function is confirmed with the enter key **E**. Additional functions under further index numbers (1 to 10) can then be selected for binary input 1 using the **▼** key. Each

selection must be confirmed with the **E** key. If the slot of a physical module is not assigned, the "not all." function (not allocated) is selected.

You can exit the selection level of binary input 1 with the **◀** key. The **▼** key takes you to the next binary input.

Table 5.1 Marshallable binary input functions

FNo.	Short text (display on LCD)	Logical function
1	not all.	Not allocated
5	>LEDr.	>Reset LED indicators
1157	>CBclo	>Circuit breaker closed
3003	>Dif.bl	>Block differential protection
3008	>Res.LO	>Lockout reset
3303	>TT.blk	>Block transfer trip transmitter
3306	>Tr.TRP	>Transfer trip signal input
3333	>Re.blk	>Block of trip receiver
3363	>PWM.bl	>Block pilot wire monitor

5 Preparation Instructions

An overview of the factory settings for the binary inputs is provided in table 5.2.

Table 5.2 Factory set binary inputs

4th operating level	5th operating level	FNo.	Comment
MARSHALLING	BINARY INPUTS		Block heading
61 MARSH BI 1	6 1 B I 1 1 > D i f . b l	3003	>Block differential protection
61 MARSH BI 2	6 1 B I 2 1 > R e s . L O	3008	>Lockout Reset
61 MARSH BI 3	6 1 B I 3 1 > L E D r .	0005	>Reset LED indicators

5.5.3 Marshalling of signal relay - block 62

The device has 3 signal outputs (signal relays). Assignment of signal relay SIG.RE1 is fixed with the indication "Protection ready". This indication appears when the self-monitoring of the device has not detected any faults.

The other signal relays SIG.RE2 and SIG.RE3 can be marshalled in block 62. You can reach the block from the initial state of the device in level 1 as follows: Press the ▼ key (forwards), switch to the 2nd operating level with the ► key (next level), scroll with the ▼ key until block 60 appears on the display. Switch to operating level 3 with the ► key and scroll to block 62 with the ▼ key →: Marshalling signal relay. Selection is carried out as described in section 5.5.1. Multiple indications are permitted, i.e. a logical indication can be transmitted to several signal relays (see section 5.5.1).

Table 5.3 shows a list of all the signal functions with their respective function numbers Fno. Signal functions have no effect if the relevant protective function of the device is not available or has been configured so that it is not available.

The general diagrams in appendix A show the assignment of the signal relays on delivery. The following boxes show some examples of these. Table 5.4 contains a complete list of all presettings.

Notes regarding table 5.3. The indications starting with ">" are direct feedback information of the binary input and have identical status to the binary input. They appear as long as the relevant binary input is actuated.

For further information on the indications, see section 6.4.

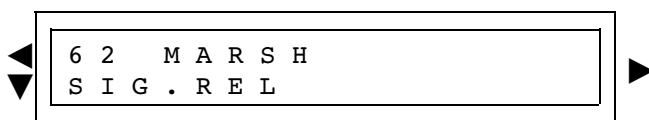

[6200]

Beginning of the block "Marshalling of signal relays"

Use the ► key to go to the first signal relay:

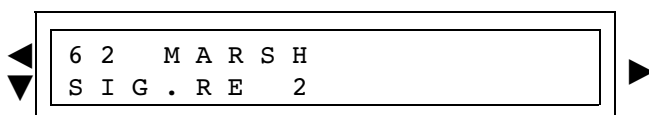

[6222]

Marshalling for signal relay 2:

Switch to the selection level with the **▶** key:

```

6 2   S I G 2   1
P W . f a i l
    
```

[6223]

Signal relay 2 has the following factory setting:
Pilot wire monitor: Failure detected

```

6 2   S I G 2   2
not a l l .
    
```

[6224]

No further signal functions for signal relay 2

The "+" key lets you call up all marshallable output functions on the display once you have entered the code word. The "-" key also lets you scroll backwards through the list of alternatives. Confirm the required function with the enter key **E**. Additional functions under further index numbers (1 to 20) can then be

selected for signal relay 1 using the **▼** key. Each selection must be confirmed with the **E** key. If the slot of a physical module is not assigned, the "not all." function (not allocated) is selected.

Exit the selection level of signal relay 1 with **◀**. Scroll to the next signal relay with the **▼** key.

Table 5.3 Marshallable binary output functions

Fno.	Short text (display on LCD)	Logical function
1	not all.	Not allocated
5	>LED r.	>Reset LED indicator
52	operat.	Any protection operative
501	FT det	General fault detection of device
511	DEV.Trp	General trip of device
1157	>CBclo	>Circuit breaker closed
1174	CBtest	Circuit-breaker test in progress
1185	CBtpTST	Circuit-breaker test: Trip 3-pole
3003	>Dif.bl	>Block differential protection
3008	>Res.LO	>Lockout Reset
3015	Dif.off	Differential protection is switched off
3016	Dif.blk	Differential protection is blocked
3017	Dif.act	Differential protection is active
3021	Dly.st	Differential protection: IDIFF> time deley started
3022	Dif.flt	Differential protection: General fault detection
3024	Block.S	Differential protection:Blocked by external fault
3026	Block.H	Differential protection:Blocked by harmonics
3027	Dif.TRP	Differential protection: Trip by IDIFF>
3028	IntTrp.	Differential protection: Intertrip send signal
3030	B. Dif D	Differential protection: Blocked by IDIFF supervis.
3031	Lockout	Trip-Lockout is in progress
3303	>TT.blk	>Block transfer trip transmitter
3306	>Tr.TRP	>Transfer trip signal input
3312	TT.blkd	Transfer trip transmitter is blocked
3316	TT.Send	Transfer trip transmission signal
3333	>Re.blk	>Block of trip receiver
3341	Rec.off	Trip receiver is switched off
3342	Rec.blk	Trip receiver is blocked
3343	Rec.act	Trip receiver is active

5

Preparation Instructions

Table 5.3 Marshallable binary output functions

Fno.	Short text (display on LCD)	Logical function
3346	Rec.flt	Trip receiver: General fault detection
3347	Rec.TRP	Trip receiver: General trip
3348	Rec.rec	Trip receiver: Trip signal received
3363	>PWM.bl	>Blocking of pilot wire monitoring
3371	PWM.off	Pilot wire monitor is switched off
3372	PWM.blk	Pilot wire monitor is blocked
3376	PW.fail	Pilot wire monitor: Failure detected

Table 5.4 Factory set indications on signal relay

4th operating level	5th operating level	FNo.	Comment
MARSHALLING	Signal relay		Block heading
62 MARSH SIG.RE 2	6 2 S I G 2 1 P W . f a i l	0001	Pilot wire monitor: Failure detected
62 MARSH SIG.RE 3	6 2 S I G 3 1 L o c k o u t	3031	Trip-Lockout is in progress

5.5.4 Marshalling of the LEDs - block 63

The device has 6 LEDs for optical display, 4 of which can be marshalled. These are designated LED 1 to LED 4 and can be marshalled in block 63. The block may be reached from the initial state of the device in level 1 as follows: Press the ▼ key (forwards), switch to the 2nd operating level with the ► key (next level), scroll with the ▼ key until block 60 appears on the display. Switch to operating level 3 with the ► key and scroll forwards to block 63 with the ▼ key →: MARSHalling LED. Selection is carried out as described in section 5.5.1. Multiple indications are permitted, i.e. a logical indication can be transmitted to several LEDs (see section 5.5.1).

In addition to the logical function itself, it may also be selected whether each LED is to operate as memorized or not memorized. When scrolling with the "+" key, each signal function for the LED is displayed either without a status indication (not memorized) or with the index "m" (m = memorized).

The marshallable signal functions are the same as those listed in table 5.3. Signal functions have no effect if the relevant protective function in the device has been configured so that it is non-existent.

The selected function must be confirmed with the enter key **E**.

The front view of the device (Figure 6.1) shows the assignment of the LED on delivery. The following boxes show an example assignment for binary input 1. Table 5.5 shows all factory settings.

```

6 3  M A R S H
L E D  I N D
    
```

[6300]

Beginning of the blocks "Marshalling of the LEDs"

Use the **▶** key to go to the first marshallable LED:

```

6 3  M A R S H
L E D  1
    
```

[6301]

Marshalling for LED 1

Switch to the selection level with the **▶** key:

```

6 3  L E D 1  1
L o c k o u t
    
```

[6302]

LED 1 is factory set as follows:

1. Lockout FNo. 3031

```

6 3  L E D 1  2
n o t a l l .
    
```

[6303]

2. No further signal functions for LED 1

The "+" key lets you call up all marshallable output functions on the display once you have entered the code word. The "-" key also lets you scroll backwards through the list of alternatives. The required function is confirmed with the enter key **E**. Additional functions under further index numbers (1 to 20) can then

be selected for LED 1 using the **▼** key. Each selection must be confirmed with the **E** key. If the slot of a physical module is not assigned, the "not all." function (not allocated) is selected.

You can exit the selection level of LED 1 with the **◀** key. Scroll to the next LED with the **▼** key.

Table 5.5 Factory set LEDs

4th operating level	5th operating level	Fno.	Comment
MARSHALLING	LEDs		Block heading
63 MARSH LED 1	6 3 L E D 1 1 L o c k o u t	3031	Trip-lockout is in progress
63 MARSH LED 2	6 3 L E D 2 1 D E V . T r p	511	General trip of device
63 MARSH LED 3	6 3 L E D 3 1 P W . f a i l	1	Pilot wire monitor: Failure detected
63 MARSH LED 4	6 3 L E D 4 1 B l o c k . S B l o c k . H B . D i f . D	3024 3026 3030	Diff.prot.: Blocked by external fault Diff.prot.: Blocked by harmonics Diff.prot.: Blocked by IDIFF supervis.

5

Preparation Instructions

5.5.5 Marshalling of the command relays - block 64

The device has 2 command relays with trip duty, designated as CMD.RE 1 and CMD.RE 2. They can be marshalled in block 64. You can reach the block from the initial state of the device in level 1 as follows: Press the ▼ key (forwards), switch to the 2nd operating level with the ► key (next level), scroll with the ▼ key until block 60 appears on the display. Switch to operating level 3 with the ► key and scroll to block 64 with the ▼ key →: Marshalling command relay. Selection is carried out as described in section 5.5.1. Multiple commands are permitted, i.e. a logical indication can be transmitted to several command relays (see section 5.5.1).

All indications shown in table 5.3 can be marshalled to command relays. Command functions have no effect if the relevant protective function in the device is not available, switched off or has been configured so that it is not available or is parameterized as indication only.

The general diagrams in appendix A show the assignment of the command relays on delivery. The following boxes show some examples for command relay 1.

Table 5.6 shows all factory settings.

If several protective functions are to trip the same circuit breaker, the relevant command relay must be activated by the relevant command function.

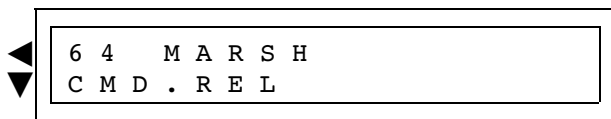

[6400]

Beginning of the block
"Marshalling of command relays"

Use the ► key to go to the first command relay:

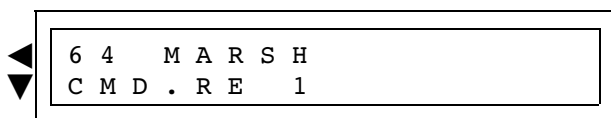

[6401]

Marshalling for command relay 1

Switch to the selection level with the ► key:

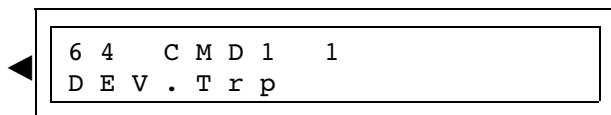

[6402]

Command relay 1 is factory set as follows:

1. General trip of device; FNo. 511.

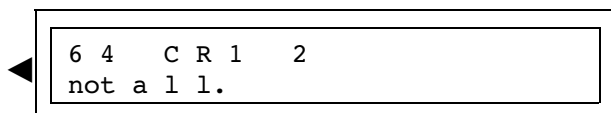

[6403]

2. No further command functions for command relay

The "+" key lets you display all marshallable output functions once the code word has been entered. The "-" key also lets you scroll backwards through the list of alternatives. The required function is confirmed with the enter key **E**. Additional functions under further index numbers (1 to 20) can then be selected for

command relay 1 using the ▼ key. Each selection must be confirmed with the **E** key. If the slot of a physical module is not assigned, the "not all." function (not allocated) is selected.

Exit the selection level of command relay 1 with ◀. Scroll to the next command relay with the ▼ key.

Table 5.6 Factory set command functions

4th operating level	5th operating level	FNo.	Comment
MARSHALLING	COMMAND RELAY		Block heading
64 MARSH CMD.RE 1	6 4 CMD1 D e v. Tr	511	General trip of device
64 MARSH CMD.RE 2	6 4 CMD2 D e v. Tr	511	General trip of device

6 Operating Instructions

6.1 Safety measures



Warning

The safety regulations applicable to working in power plants must be observed for testing and commissioning.



Caution

Operating the device on a battery charger without a battery connected can lead to unacceptably high voltages and to destruction of the device. See also table 3.1 under Technical data.

6.2 Operating the device

Digital protection devices as well as automatic devices are operated with dialog between the operator and the device via the integrated keypad and display panel on the front of the device. All the parameters necessary for operation can be entered all information can be read out. Operation with a PC is also possible through the serial interface for example.

6.2.1 Membrane keypad/Display panel

Figure 6.1 shows the front view of the device.

A two-line LCD with 8 characters per line (display panel) is available as a display. Each character is displayed in a 5x8 dot matrix. The numerics, letters and a number of special characters are displayed.

A two-digit number appears in the top line of the display panel for parameters. This number indicates the operating block.

The control panel consists of 9 keys with Yes/No and control keys with which it is possible to move through

the hierarchically structured operating menu tree. The individual keys have the following meanings:

Keys for changing numerical values and alternative text values:



Increase the values, starting from the default value



Decrease the values, starting from the default value

Yes/No keys



Yes key: The operator answers the question in the display with yes



No key: The operator answers the question in the display with no; this key also serves to delete stored displays (LEDs and fault events)

Keys for scrolling in the display



Scroll forwards: the next operating position in the same operating level appears in the display



Scroll backwards: the previous operating position in the same operating level appears in the display



Scroll forwards to the next operating level: the corresponding operating object of the next operating level appears in the display



Scroll backwards to the previous operating level: the corresponding operating object of the previous operating level appears in the display

Confirmation key



Enter key: All changes in the display by means of entered numbers or changes via the "Yes/No" keys must be confirmed with the Enter key; only then will the device register the changes. The Enter key may also be used to acknowledge a faulty reaction of the device; in this case, the entry must be repeated and re-confirmed with the Enter key.

The spontaneous system disturbance information in the display can be acknowledged by pressing the "No" key **N** and the quiescent display data called up again. During the reset, the marshallable LEDs on the front are illuminated so that these can be checked.

6.2.2 Operation with a PC

A PC (with MS WINDOWS operating system) and the DIGSI® operating program enables the setting, starting of test sequences and retrieval of data, as do the integrated keypad and display. However, the PC allows for the convenience of visualization on a monitor and menu-guided execution.

All data can be saved on or retrieved from floppy disks (e.g. for parameterization).

In addition, all data can be printed out on a printer.

In the case of operation with a PC, the applicable manuals must be observed. The DIGSI® software is suitable for the processing of all protection data. An overview of operating programs and accessories (connection cable etc.) suitable for 7SD600 can be found in section 2.3 Ordering data.

6.2.3 Prerequisites for operation

A code word entry is required for most operation functions. This applies to all entries via keypad or operator interface which affect the functions in the device such as :

- Setting of function parameters (threshold values, functions),
- Marshalling of trip relays, signals, binary inputs, LEDs,
- Configuring of parameters for operating language, interface and device configuration,
- Starting of test sequences.

Code word entry is not required to read out signals, operational data, failure data or for the retrieval of setting parameters.

The entry of the code word as well as adaptation of the PC interface is described in the preparation instructions under section 5.3.

6.2.4 Front view of the device

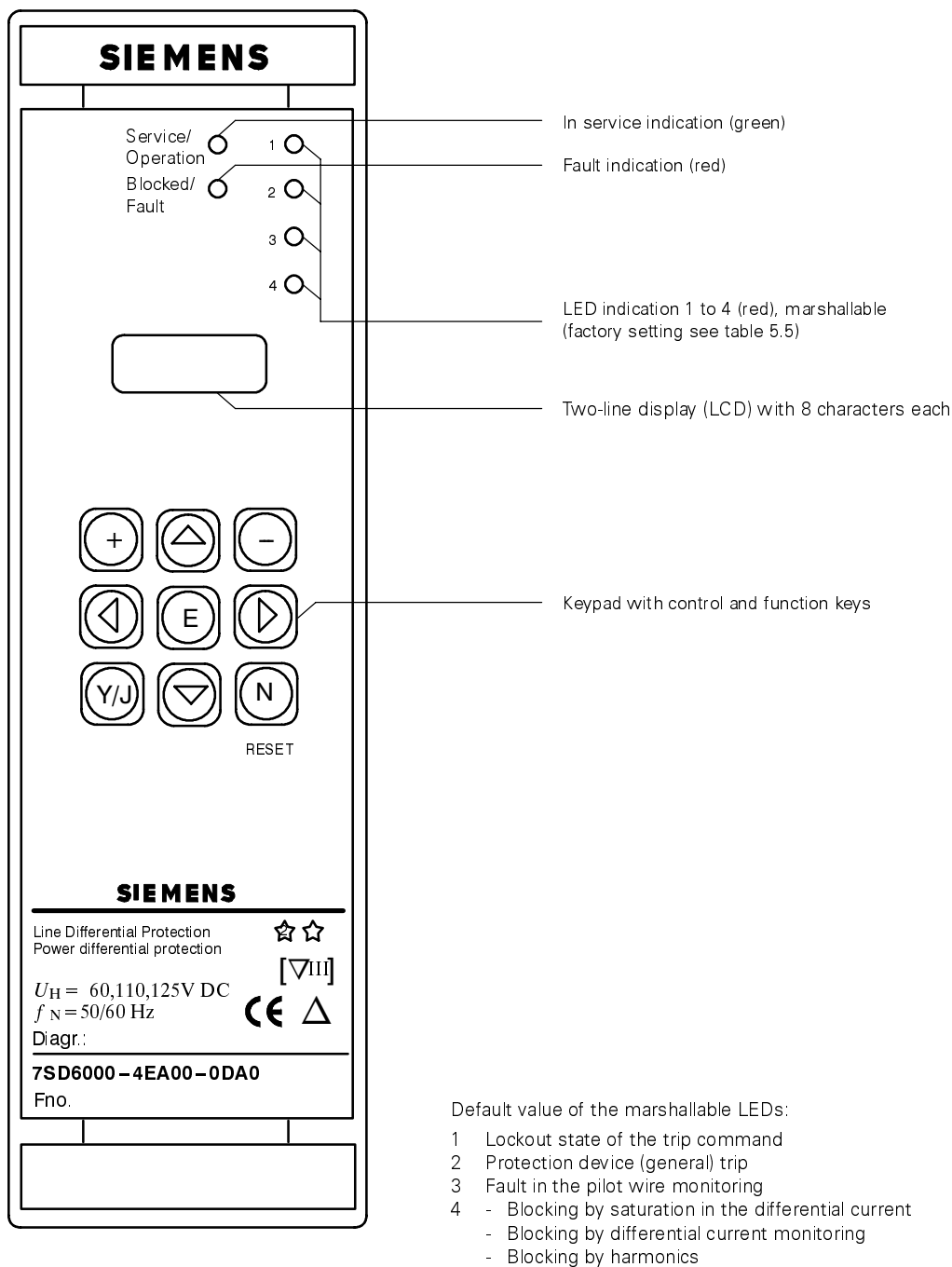

Figure 6.1 Front view of 7SD600 with control panel and displays

6 Operating Instructions

6.3 Setting of function parameters

6.3.1 Introduction

6.3.1.1 Procedure for parameterization

The operator interface consists of a hierarchically structured menu tree which can be moved through with the scroll keys ◀, ▶, ▲ and ▼ to reach every desired operating object. A general overview is given in the appendix A.1.

The initial position in the relay which is switched on and in service, can be left to reach the parameterization area by pressing the key ▼. The "PARAMETER settings" item appears, which contains all parameter blocks. With the ▶ key the next operating level is reached. Initially the operating block for the configuration appears. This was dealt with in sections 5.3 and 5.4.

The parameter blocks are reached by pressing the ▼ key. Block 01 with the "POWER SYSTEM DATA" appears first.

Other parameter blocks follow after repeated pressing of the ▼ key providing the appropriate functions are available in the device and these have been configured as AVAILABLE.

Press the ▶ key to jump to the next operating level in which the actual parameterization, i.e. the setting of threshold values or selection of offered alternatives takes place.

If, for example, the ▶ key is pressed, starting at block 01 ("POWER SYSTEM DATA"), the 3rd operating level with the individual power system data may be reached (see Figure 6.2):

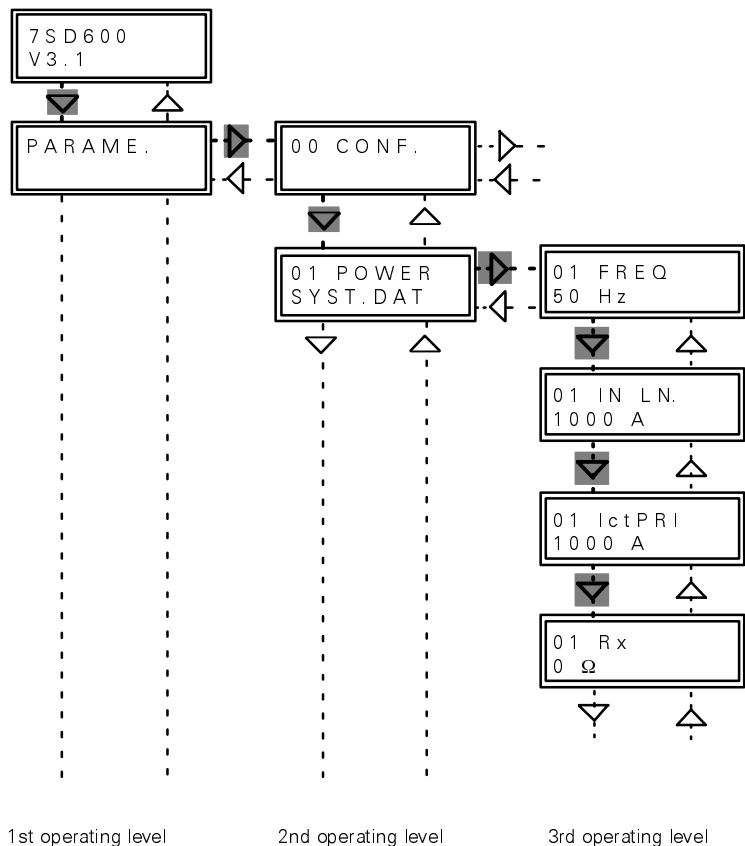
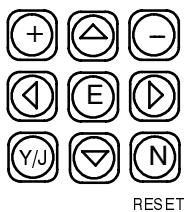

Figure 6.2 Selection of parameters for the system and station data

The code word must be entered to set the function parameters (see 5.3.1). Without the code word, the settings can be read but not changed.

Parameterization can begin when the code word has been accepted. In the following sections every address is shown and explained in a box. There are three types of displays:

- Setting addresses without operating prompt

A displayed text forms the header for an operating block. The parameter block number (two-digit number in the left of the display) appears. No input is expected. The previous or next operating block without an operating prompt (header) is reached by pressing the ▲ or ▼ keys. Switch to the next operating level with the ► key.

- Setting addresses with numeric input

The display shows a two-digit block number in the top left of the line. After this the meaning of the requested parameter is displayed in abbreviated form. The second display line contains the parameter value. A default value is set at the factory prior to delivery. This is specified in the following sections. No other inputs are necessary if the default value is to be retained. You can scroll to the next (or previous) parameter in the block or the next (or previous) operating level. If the value is to be changed, this can be done with the "+" or "-" keys. These are used to increase or decrease the value starting at the default value. If one of the keys "+" or "-" is pressed continuously, this acts as a repeat key function. The repeat key function becomes faster, the longer the key is kept pressed. In this way, changes can be made over a wide setting range in fine stages but still quickly and comfortably. The possible setting range is specified next to the representation of the box. When the maximum value is reached with "+", further pressing of this key will be ignored. The same applies on reaching the minimum value and pressing the "-" key. **Then the input must be confirmed with the Enter key E!** The value accepted by the device then appears. This becomes effective immediately after pressing the Enter key E.

- Setting addresses with text parameters

The display shows the two-digit block number and meaning of the requested parameter. The second display line contains the parameter text. A default

text is set at the factory prior to delivery. This is specified in the following sections. No other inputs are necessary if the default text is to be retained. You can scroll to the next (or previous) parameter in the block or the next (or previous) operating level. The default text can be changed by pressing the "+" or "-" key. The next text then appears which is appended to the bottom of the display box in the following representations etc. The alternative to be selected is confirmed with the Enter key E. Further pressing of this key is ignored when the last alternative suggestion is reached with the "+" key. The same applies when the first alternative suggestion is reached by pressing the "-" key.

The parameterization of all setting values is explained in the following sections. The arrows ▼▲ or ►◀ next to the display box provide directions on reaching the next named operating object. If the meaning of a parameter is unclear, the default parameter is usually the best option. Unoccupied operating blocks are skipped.

Every setting parameter is identified by a four-digit address number when operating a device by means of a PC and the operating program DIGSI®. This is specified in square brackets in the explanation text in the following representations.

If you attempt to scroll forwards with the arrow keys without confirming a started change by pressing the Enter key E, a question appears: "SAVE NEW SETTING?". Press the "Yes" key Y/J to confirm that the new setting is valid as of now. The new value or text is displayed. If, on the other hand, you press the "No" key N, the change made since last pressing the Enter key E is rejected and the old value or text is displayed. In this way, an accidental change can be pre-empted. To actually scroll, the appropriate arrow key must be pressed again.

If you terminate the change to an operating parameter by pressing the Enter key E the appropriate data immediately become valid and are permanently stored in non-volatile EEPROMs.

6

Operating Instructions

6.3.1.2 Setting date and time

The date and time should not be set until the protection device has been connected to the auxiliary supply voltage at its final operating site, because a failure of the auxiliary supply voltage will reset the time.

The appropriate operating block may be reached from the initial position of the device as follows: By pressing the ▼ key three times the block "ADDITION FUNCTION" is reached. With the ► key you change to the next operating level (Block "TIME SETTING"). By changing the level again with ► the date and time can be readout initially. The operating blocks for setting date and time are called up by scrolling with ▼ as displayed below.

After the device starts up 01.01.98 initially appears as the date and the time being a relative time since the system processor last started (connection of the auxiliary supply voltage).

No code word is necessary to change the date and time. The day, month and year are set by pressing the "+" and "-" starting from the default value. Then the setting must be confirmed with the Enter key **E**. The same applies accordingly for the hours and minutes of the time.



Note

When entering the day, a maximum number of 31 days is assumed so that this value can be selected in all cases. The device only recognizes whether the input is plausible after the month and year (leap year or not) have been entered. After pressing the Enter key **E** automatic limiting to a real date takes place.

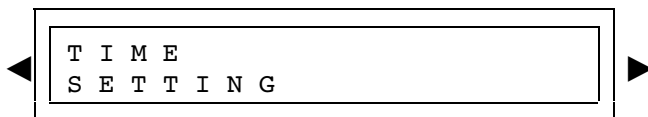

[8100]

Start of block "TIME SETTING"

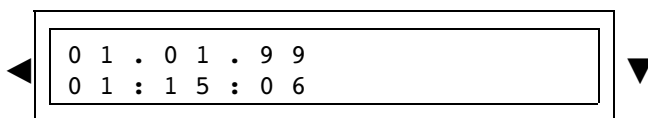

[8101]

First the "current" date (**DD. MM.YY**) and the current time (**HH:MM:SS**) are displayed. The actual setting blocks are reached with ▼.

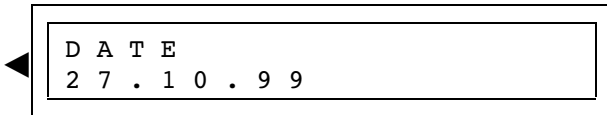

[8102]

A new date can now be entered. This is done in the order: day, month, year **DD ▶ MM ▶ YY**

Starting at the default value, the day is increased to the current date by pressing the "+" key. The ▶ key is pressed to reach the month. By pressing the "+" key, the month is increased until the current month is reached. Thereafter, the year is selected with ▶ and increased with the "+" key until the current year is reached. The values can be decreased with "-". Finally the whole date input is confirmed by pressing the Enter key **E**.

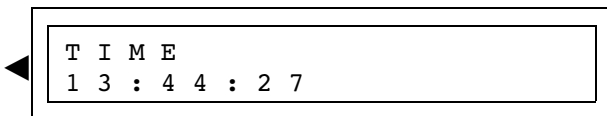

[8103]

To switch from the data setting to the time setting, ▼ is pressed. A new time can now be entered. This takes place in the order: hours, minutes: **HH ▶ MM**

Starting from the default value first, the hour is increased to the current hour by pressing the "+" key. Then change to the minutes by pressing the ▶ key and increase the hour to the current value with "+". The values can be decreased with the "-" key.

There is no need to set the seconds. The seconds are automatically set to zero when the time input is confirmed.

The complete time input is confirmed and becomes active on pressing the Enter key **E**.

6.3.2 Initial display

After switching on, the protection device logs in with a type designation, the so-called MLFB (German for **M**achine**R**eadable **M**ake**D**enomination) and the version of the implemented firmware. About 30 s after

switching on, the display switches over and the quiescent state indications (currents I_1 and I_D) are displayed. The initial display can be recalled from this state by pressing the ▼ key and then pressing the ▲ key.

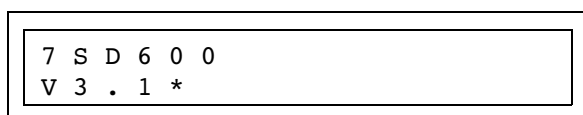

The device logs in with the type designation. The version of the implemented firmware is displayed in the second line.

The setting parameters start at block 01. These are reached from the initial display by pressing the ▼ key (see also Figure 6.2).

6

Operating Instructions

6.3.3 System and station data - Block 01

The device requires some power system data.

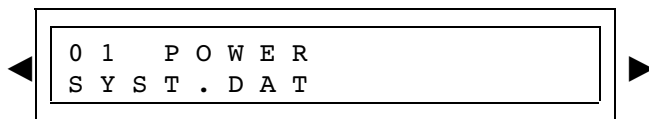

[1100]

Start of the block "POWER SYST.DAT"

The rated frequency of the system is the first setting in this block. The default value 50 Hz need only be changed if the system frequency is 60 Hz.

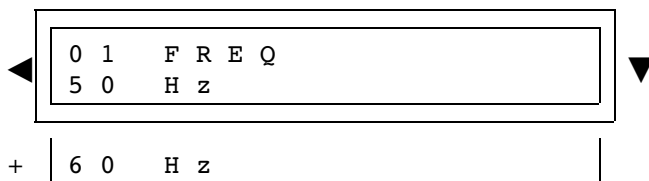

[1101]

Rated frequency of the system *50* or *60 Hz*

The primary rated current of the protected plant (addr. **01 IN LN.**) and the primary rated current of the current transformer (addr. **01 IctPRI**) can be set to the same value in most cases. The correct setting of the rated current of the transformer is a prerequisite for calculating and displaying the primary measured current values (see also section 6.4.4). **Specification of the rated current of the protected plant allows optimum adaptation of the characteristic of the differential protection to the protected plant because the pick-up thresholds and shape of the characteristic are related to this rated current when set correctly.**

The two rated currents I_{ctPRI} / I_{NLN} should not differ by more than a factor 4.

Example:

Rated current of the protected plant: 1000 A
Current transformer rated current: 2000 A

The device then refers pick-up thresholds and shape of characteristic to a current which corresponds to 1000 A primary. The characteristic refers to 1000 A primary as a result.

Both parameters must be set to the same at both ends of the line. If the primary transformer rated currents are different, they must be made equal by connecting interposing at the end of the line with the lower rated current. See section 5.2.4.4 for details.

0 1	I N L N .
1 0 0 0	A

[1102]

Primary rated current of the protected plant (of the line)

smallest setting value: 1 A

largest setting value: 100 000 A

0 1	I c t P R I
1 0 0 0	A

[1103]

Primary current of the current transformer

smallest setting value: 1 A

largest setting value: 100 000 A

It is not necessary to balance the pilot wire resistances by additional resistors in 7SD600 because the device provides internal matching automatically by calculation. However, the wire resistance must be entered to enable it to do this (addr. **01 Rx**). In addition to the loop resistance of the pilot wires a resistance of 80 Ω must be added for the pilot wire monitoring (if installed). A further 60 Ω must be added for every isolating transformer 7XR95. The device can measure the wire resistance itself during commissio-

ning (see section 6.6) . It's recommended to use this function to achieve optimal setting conditions.

In addr. **01 T-TRP** the minimum trip command duration is set. It applies to all protective functions which can initiate tripping and is maintained even if the circuit-breaker has switched off the short-circuit current earlier.

In addr. **01.L.Out** and **01L.O.Re** the possibility of switching the Lockout function on and off and of selecting the type of Reset is given.

0 1	R x
0	Ω

[1131]

Loop resistance of the pilot wire pair

smallest setting value: 0 Ω

largest setting value: 2 000 Ω

0 1	T - T R P
0 . 2 0	s

[1134]

Minimum duration of the trip command

smallest setting value: 0.01 s

largest setting value: 60.00 s

0 1	L . O u t
O F F	

[1135]

Switch off the Lockout function

O N

Switch on the Lockout function

6

Operating Instructions

0 1 L . O . R e
b u t t o n

[1136]

Resetting the Lockout function:
with LED acknowledge key;

b i n . i n p .

via binary input;

b u t . o . B I

with LED acknowledge key or binary input

6.3.4 Settings for the line differential protection

The differential protection can be switched active (*ON*-) or inactive (*OFF*-); in addition the trip command may be blocked if the protective function is active.



Warning

The differential protection is selected to the *ON* state when delivered, but the protection may not be operated without at least the loop resistances being set correctly first (see addr. **01 Rx** in section 6.3.3). The device could react unexpectedly without these settings (e.g. trip)!

1 0 P L . W I R
D I F . P R O T

[1500]

Start of the block "Line differential protection"

1 0 D I F . P R
O N

[1501]

ON selection of the differential protection function

O F F

OFF selection of the differential protection function

A L R M o n l y

Differential protection is active, signals events,
but the trip command is blocked.

I_{DIFF>} (addr. **10 IDIFF>**) is the pick-up threshold for the differential current. This is the total current measured during a short-circuit in the protected zone, irrespective of its distribution on the respective line ends. The operating value is related to the rated line current set under addr. **01 IN LN**. (see section 6.3.3). An upper threshold value for the setting is given by consideration of the smallest currents which may occur for the different types of short-circuit and the respective sensitivity of the selected type of connection.

The lower limit of the permissible setting range is determined by the constant differences between the secondary currents of the summation transformer arising during unfaulted operation with load and charging currents. These differences are based on capacitive primary currents in the protected zone. Large capacitive currents, which may endanger the stability of

the protection, practically only occur in cables. Current differences (i.e. apparent fault currents) may occur on the secondary side of the summation transformers due to charging currents of the cables.

To allow for the even higher capacitive currents during transients, a larger current setting must be applied. From experience, a setting value for the lower limit, with normal sensitivity connection of the summation transformers (Figure 5.4), should be approximately equal to five times the steady state charging current flowing in each conductor of the unfaulted system. In circuits with an even higher earth-fault sensitivity, the limit of the lower setting range must be increased accordingly. Summation CT circuits with reduced earth-fault sensitivity reduce the limit especially in earthed networks. In this case, the setting from approx. 4 times the charging current of every conductor is sufficient.

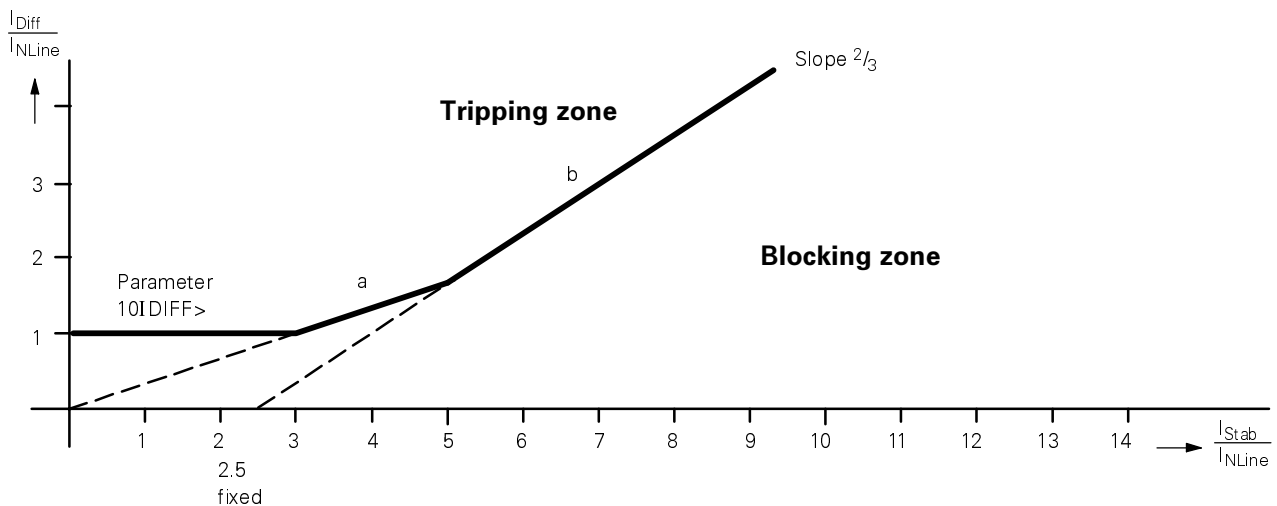

Figure 6.3 Trip characteristic of the 7SD600

The trip characteristic consists of two other segments (a and b) (Figure 6.3).

Segment "a" (the origin is the zero point) takes current-proportional error currents into account. These are mainly the transformation errors of the main current transformers and the summation transformers below the saturation level.

Segment "b" leads to a higher stabilization in the range of higher currents at which current transformer saturation may occur. Its origin is at 2.5 times the rated current of the line.

6 Operating Instructions

In cases in which a transformer is directly connected to a line, i.e. without current transformer and circuit-breaker, an in-rush stabilization with the second harmonic can be selected (addr. **10 HARM2**). The percentage component of the second harmonic required for stabilization can be parameterized under addr. **10 HARM2%**. A ratio I_{2fN}/I_{fN} of 20 % is factory set. This is sufficient in most cases. A smaller value leads to greater stabilization, a higher value to lower stabilization.

Exceeding the limit leads to blocking of the differential protection.

This block can be removed immediately when the differential current exceeds a set current threshold (addr. **10 HARM2I**).

A prerequisite for this, however, is that the device is equipped with the 2nd harmonic option (model 7SD600*_*****-1, 7SD600*_*****-3).

1 0 I D I F F >
1 . 0 0 I n L

[1503]

Pick-up value for differential current during three-phase symmetrical current flows referred to the rated line current

smallest setting value: **0.50** $I_{N \text{ line}}$
largest setting value: **2.50** $I_{N \text{ line}}$

1 0 I I R E L .
0 . 0 0 I n L

[1523]

Local current threshold for releasing tripping of the differential protection related to rated line current

smallest setting value: **0.00** $I_{N \text{ line}}$
largest setting value: **1.50** $I_{N \text{ line}}$

1 0 T - D L Y .
0 . 0 0 s

[1525]

Delay of trip command

smallest setting value: **0.00** s
largest setting value: **60.00** s

1 0 H A R M 2
O F F

[1510]

The in-rush stabilization with the second harmonic restraint is

switched OFF or

O N

switched ON

1 0 H A R M 2
2 0 %

[1511]

Component of 2nd harmonic in the differential current which only just leads to blocking in % of the fundamental frequency component of the differential current

smallest setting value: **10** %
largest setting value: **80** %

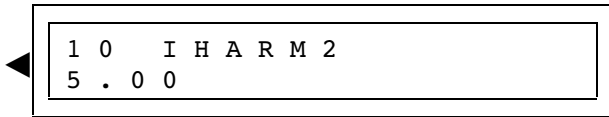

[1512]

Differential current threshold for resetting the blocking by the 2nd harmonic

smallest setting value: **1** $I_{N \text{ line}}$

largest setting value: **20** $I_{N \text{ line}}$

The differential protection has a local current threshold I1 RELEASE. (addr. **10 I1REL.**) which monitors the locally flowing current and provides an additional trip criterion. This setting value also refers to the rated current of the line as set under addr. **01 IN LN.** (see section 6.3.3).

Tripping of the line at both ends, even during weak infeed conditions, is achieved by setting "0".

In special applications it may be of advantage to delay the trip command of the protection slightly (e.g. for reverse interlocking). An additional time delay can be set for this (addr. **10 T-DLY**). This is normally set to 0.

The line differential protection may have an integrated intertrip function. Since this information must be transferred through the pilot-wire connection, it is coupled to the version with pilot wire monitoring (7SD600★-★★★-2, 7SD600★-★★★-3).

during weak infeed or weak loading conditions. In this case, the intertrip function is recommended to switch off both ends of the line.

A received intertrip signal may lead to tripping or only to signaling (LED or signal relay depending on the marshalling). See section 6.3.7 for details.

If the local current threshold (addr. **10I1REL.**) is set greater than "0", single-ended tripping may occur

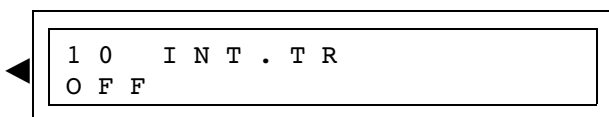

[1541]

Condition for sending the intertrip signal:

Transmission function switched OFF;



or intertrip signal is transmitted

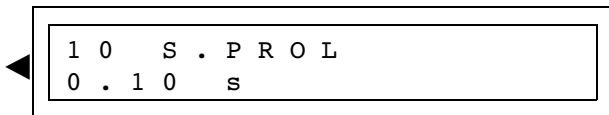

[1542]

Prolongation of the intertrip signal after drop off of the differential protection

smallest setting value: **0.00** s

largest setting value: **5.00** s

6

Operating Instructions

A current threshold can be set for blocking by the differential current monitoring function ("Spill current") (**addr. 10 I-SpC**) with the settable delay (**addr. 10 T-Spc**).

Due to the capacitance of the pilot wires, the protection detects a differential current which is dependent on the line length and the load current. A reference

value for this differential current can be calculated with the following equation:

$$I_{diff} (\%) = 0.025 I_{operation} (\%) \times L (\text{km}) \text{ for } f = 50 \text{ Hz,}$$

$$I_{diff} (\%) = 0.033 I_{operation} (\%) \times L (\text{km}) \text{ for } f = 60 \text{ Hz.}$$

The parameter 10 I-SpC must be set greater than this value.

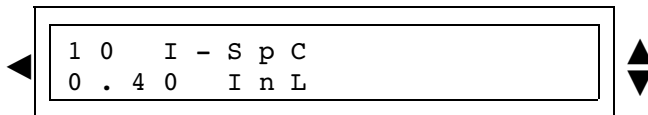

[1550]

Current threshold for differential current monitoring (Spill Current)

smallest setting value: **0.10** $I_{N \text{ line}}$
 largest setting value: **1.00** $I_{N \text{ line}}$
 and "∞" for inductive

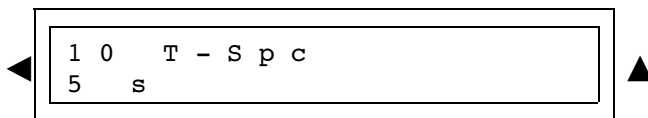

[1551]

Delay for differential current monitoring

smallest setting value: **5** s
 largest setting value: **60** s

6.3.5 Settings for the pilot wire monitoring

The device can be equipped with a pilot wire monitoring to monitor the healthy state of the pilot wires. This is available in the versions 7SD600★-★★★-2 and 7SD600★-★★★-3. A further precondition for this function (see Section 5.4.2) is that **addr. 00PL.MON = Existent** was set when configuring the device functions. The pilot wire monitoring can also be switched *OFF* and *ON* under **addr. 11PL.MON**.

The pilot wire monitoring operates with a pulse code which is modulated onto an AF signal (2000 Hz). The signals can only be transmitted in one direction at a time. The direction alternates in order to be able to create defined start conditions when switching on the devices or after an auxiliary supply failure, one of the two connected devices must be appointed "Master"

and the other as "Slave". The "Master" device always starts the signal traffic, the "Slave" device simply replies. The appropriate ID is set under **addr. 11STATN**.

If a fault in the pilot wire connection is detected, this can either be reported only or the differential protection is blocked additionally (**addr. 11DIF.BL**). If the pilot wire is interrupted, the differential protection cannot trip anyway; in the event of a pilot wire short-circuit, on the other hand, the device would also trip in the event of an external short-circuit. Reporting of the wire fault and blocking if necessary are delayed by the time (**addr. 11T-PLT.**).

The pilot wire monitoring does not operate as long as there is a fault or a transfer trip or intertrip command being transmitted.

<div style="border: 1px solid black; padding: 2px; margin-bottom: 2px;">1 1 P I L O T</div> <div style="border: 1px solid black; padding: 2px;">W I R E M O N .</div>	<p>[1600] Start of the block "Pilot wire monitoring"</p>
<div style="border: 1px solid black; padding: 2px; margin-bottom: 2px;">1 1 P L . M O N</div> <div style="border: 1px solid black; padding: 2px;">O N</div>	<p>[1601] Pilot wire monitoring switched ON</p>
<div style="border: 1px solid black; padding: 2px; margin-bottom: 2px;">O F F</div>	<p>switched OFF</p>
<div style="border: 1px solid black; padding: 2px; margin-bottom: 2px;">1 1 S T A T N .</div> <div style="border: 1px solid black; padding: 2px;">S L A V E</div>	<p>[1602] Station ID for data traffic SLAVE - slave transmitter (answers only)</p>
<div style="border: 1px solid black; padding: 2px; margin-bottom: 2px;">M A S T E R</div>	<p>MASTER - master transmitter (starts with data traffic)</p>
<div style="border: 1px solid black; padding: 2px; margin-bottom: 2px;">1 1 D I F . B L</div> <div style="border: 1px solid black; padding: 2px;">O N</div>	<p>[1603] Blocking of the line differential protection after detecting pilot wire failure switched ON</p>
<div style="border: 1px solid black; padding: 2px; margin-bottom: 2px;">O F F</div>	<p>switched OFF</p>
<div style="border: 1px solid black; padding: 2px; margin-bottom: 2px;">1 1 T - P L T .</div> <div style="border: 1px solid black; padding: 2px;">5 s</div>	<p>[1604] Delay of the message after a fault detected by the pilot wire monitoring smallest setting value: 0.2 s largest setting value: 60 s</p>

6.3.6 Settings for the transfer tripping

The line differential protection has an integrated transfer trip function in the version 7SD600★-★★★-2 and 7SD600★-★★★-3 (with pilot wire monitoring, transfer tripping and intertripping). This can be used for tripping the other end of the line by a signal generated outside the 7SD600, e.g. by a circuit-breaker failure protection. The trip command is then fed to the device by a binary input to which the message 3306 >Tr.TRP is to be marshalled.

It is a precondition that during configuring of the device scope (section 5.4.2) in addr. **00PL.MON**=Existent is configured.

The parameters for processing the received signal are set in block 13 (see section 6.3.7).

The transfer trip should not be confused with the intertripping which is an integral part of the differential protection function.

The transfer tripping operates with the same AF signal (2000 Hz) as the pilot wire monitoring, but with a different pulse code. The signals can only be transmitted in one direction at the same time.

6 Operating Instructions

1 2 T R A N S
F E R T R I P

[2200]

Start of the block "Transfer trip by binary input"

1 2 S . P R O L
0 . 0 0 s

[2203]

Prolongation time for sending the transfer trip signal to the remote station

smallest setting value: **0.00 s**

largest setting value: **60.00 s**

6.3.7 Settings for tripping on receiving a remote command

It is not possible for the receiving device to distinguish whether the other device has sent a transfer trip signal or an intertrip signal. The parameters for the reaction of the device on receiving a remote command are therefore the same in both cases. They are set in address block 23.

The prerequisite for tripping when receiving a command is that the device is equipped with the supplement for pilot wire monitoring, transfer tripping and intertripping (7SD600★-★★★-2) and that the address (see section 5.4.2) **00PL.MON** has been set during configuration.

Under addr. 2301 this function can be switched *ON* or *OFF*.

1 3 T R I P
R E C E I V E R

[2300]

Start of block "Tripping by a received command signal from the remote station"

1 3 T R . R E C
O N

[2301]

Receive function: for command from the remote station:
switched ON

O F F

switched OFF

1 3 T R . D L Y
0 . 0 3 s

[2302]

Delay time for the received trip signal from the remote station

smallest setting value: **0.00 s**

largest setting value: **60.00 s**

1 3 T R . P R O
0 . 2 0 s

[2303]

Prolongation time for the received trip signal from the remote station

smallest setting value: **0.00 s**

largest setting value: **60.00 s**

6.3.8 Settings for the emergency overcurrent protection

If the differential protection becomes inactive or during a pilot-wire failure the relay can activate a definite-time overcurrent protection function.

```

1 4  E M E R G .
O / C  P R O T
    
```

[1700]

Start of the block "Emergency overcurrent protection"

```

1 4  E . O / C
O F F
    
```

[1701]

Causes for activating the "Emergency overcurrent" Function is switched off and doesn't work

```

F l t . P W M
    
```

Function is activated only with a pilot wire failure

```

D I F i n a c t
    
```

Function is activated if the differential protection function becomes inactive

```

1 4  I 1 > E M E
2 . 0 0  I n L
    
```

[1702]

Current pick-up threshold for the definite time overcurrent function

smallest setting value: **0.10**

largest setting value: **15.00**

```

1 4  T I 1 >
0 . 1  s
    
```

[1703]

Trip delay time of the overcurrent function

smallest setting value: **0.00** s

largest setting value: **60.00** s

6.4 Events (alarms)

6.4.1 Introduction

Following system disturbances, the recorded events provide an important source of information regarding the disturbance, and the functionality of the device. Furthermore, they serve to check the sequence of events in the device during testing and commissioning. They also provide information about the states of operational measuring data and the device itself during operation.

No code word need be entered for retrieving messages.

The user may access information in different ways:

- Display by LEDs on the front panel of the device (Figure 6.1),
- Binary outputs (signal relay) via the device terminals,
- Indications on the front panel display or on the screen of a PC via the interface,

Most messages can be marshalled to the LEDs and binary outputs (see section 5.5). Multiple and group messages are also possible.

To display messages on the control panel, the keys ◀, ▶, ▲ and ▼ can be used to scroll through the menu tree to the "MESSAGE" block (see Figure 6.3). From the initial position, in a device that is in service, this block is reached by pressing the ▼ key twice.

With the ▶ key, the next operating level may be reached and all message blocks can be accessed there one after the other.

When operating via a PC and the operating program DIGSI® the message addresses are identified by a four-digit address number. This is shown in square brackets with the explanation text in the following representations.

The messages are categorized as follows:

- **Block 81**
Operational events; these are indications which may occur during operation of the device: Information about the state of the device functions, measuring data etc.
- **Block 82**
Events of the last 8 network faults; starting, tripping, time processes, or similar. By definition, a network fault starts with the first fault detection of a protective function and ends with the reset of the last fault detection.
- **Block 84**
Display of operational measured values (currents).

The events and measured values are stored in lists. After selecting the desired event block, the section of the list visible on the display is shifted using the arrow keys ▼ and ▲ as shown in Figure 6.4.



[5000]

Start of the event blocks

A full list of all the event and output functions generated in the device with the corresponding function number FNo can be found in the appendix A.1.

It is also specified for every indication to where it can be signaled.

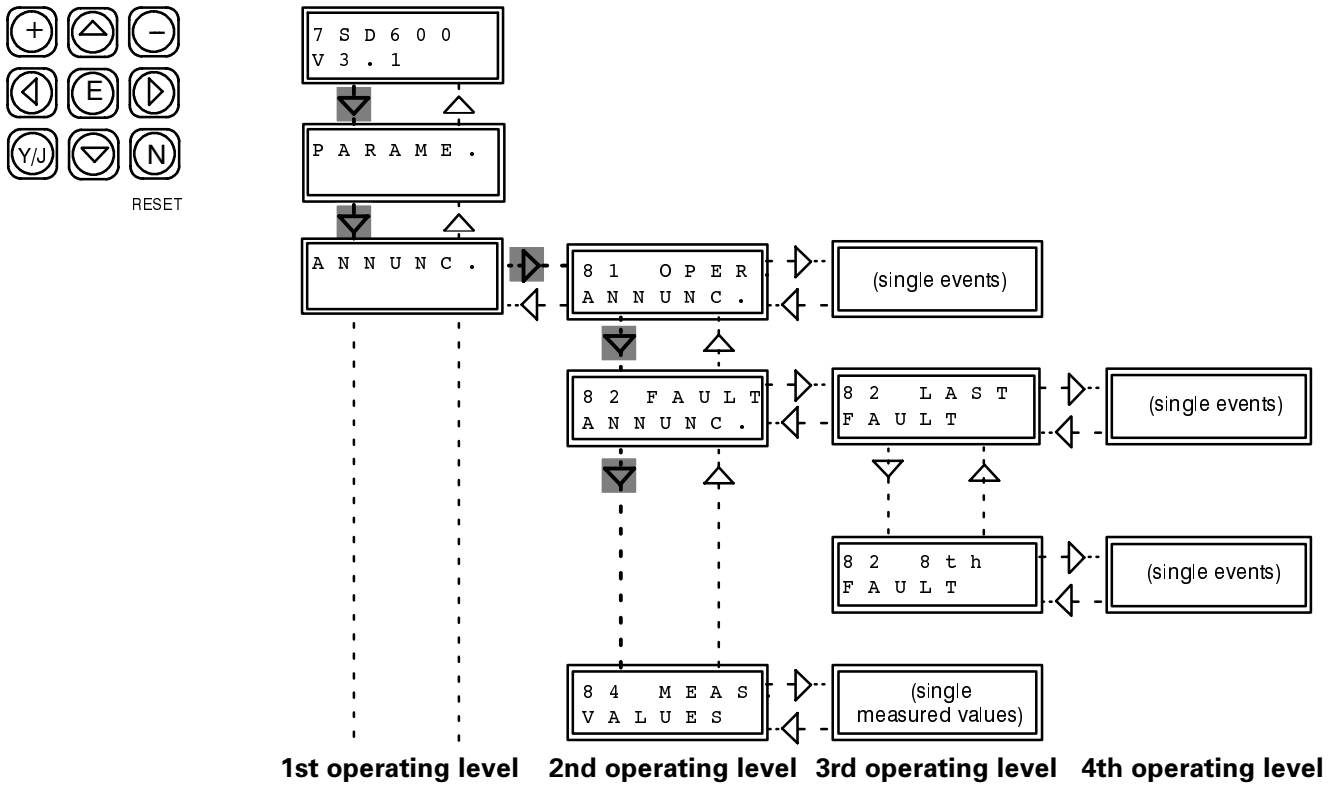

Figure 6.4 Selection of the event blocks

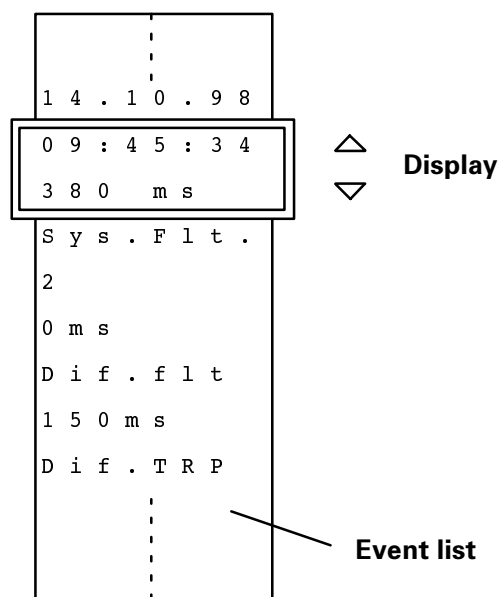

Figure 6.5 Example for displaying events in the display

6

Operating Instructions

6.4.2 Operational annunciations/events - block 81

Operational events are information which the device generates while in service, regarding its operation. They can be displayed in block 81. Important events and state changes are listed there in chronological order and with time stamps. Up to 30 operational events are stored. If there are more operational events, the eldest indication is overwritten.

Primary system faults are only specified with "Fault" and the consecutive fault number. Details about the

fault can be found in the indication block "Fault events", see section 6.4.3.

It is not necessary to enter the code word. After selecting block 81 the operational events appear. All the available operational events are displayed below. Of course only the relevant events appear in the display for the concrete case.

The abbreviations are explained next to the box. It is also specified whether the event is only coming (**C** for events) or coming and going (**C/G** for states). For the first event, display lines and the event text with coming tag in the third line is specified as an example.

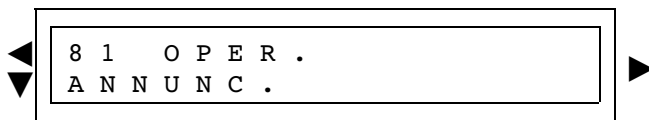

[5100]

Start of the block "Operational events"

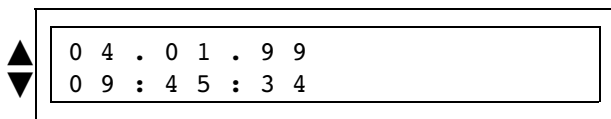

1st line: Date of the event or state changes

2nd line: Time of the event or state changes

The buffer section shown in the display is selected line by line with the arrow keys ▼ and ▲:

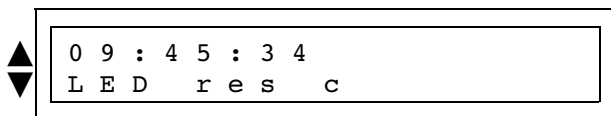

1st line: Date of the event or state changes

2nd line: Event text, in the example with coming tag

If the date and time of the device have not yet been set (see also section 6.5.1), the date 01.01.98 appears, the time that appears is a relative time since the last start of the system processor.

General operational events

A N N l o s t (0110)	Annunciations lost (buffer overflow)	(C)
P C a n n L T (0111)	Annunciations for PC lost	(C)
T A G l o s t (0113)	Fault tag lost	
R E C d e l (0203)	Fault recording data deleted	(C)
S y s . F l t (0301)	Fault in the power system	(C)
F A U L T (0302)	Flt. event w. consecutive no.	(C)

Operational events of the CB-test function

> C B c l o (1157)	>Circuit breaker closed	(CG)
C B t e s t (1174)	Circuit breaker test in progress	(CG)
C B t p T S T (1185)	Circuit breaker test : Trip 3pole	(CG)

Operational events of the line differential function

> D i f . b l (3003)	>Block differential protection	(CG)
D i f . o f f (3015)	Differential protection is switched off	(CG)
D i f . b l k (3016)	Differential protection is blocked	(CG)
D i f . a c t (3017)	Differential protection is active	(CG)
B . D i f D (3030)	Differential protection : Blocked by spill current supervision	(CG)

6 Operating Instructions

Operational events of the transfer trip function

> T T . b l k (3303)	>Block transfer trip transmitter	
> T r . T R P (3306)	>Transfer trip signal input	
T T . b l k d (3312)	Transfer trip transmitter is blocked	(CG)
T T . s e n d (3316)	Transfer trip transmission signal	(CG)
> R e . b l k (3333)	>Block of trip receiver	
R e c . o f f (3341)	Trip receiver is switched off	(CG)
R e c . b l k (3342)	Trip receiver is blocked	(CG)
R e c . a c t (3343)	Trip receiver is active	(CG)
R e c . r e c (3348)	Trip receiver : Trip signal received	(CG)

Operational events of the pilot wire monitoring

> P W M . b l (3363)	>Block pilot wire monitor	
P W M . o f f (3371)	Pilot wire monitor is switched off	(CG)
P W M . b l k (3372)	Pilot wire monitor is blocked	(CG)
P W . f a i l (3376)	Pilot wire monitor : Failure detected	(CG)

Operational events of the Lockout function

> R e s . L O (3008)	> Lockout Reset	
----------------------	-----------------	--

Operational events of the emergency overcurrent function

E M E . a c t

(2053)

Emergency O/C protection is active

(C/G)

6.4.3 Fault events/annunciations - block 82

The events of the last 8 system faults can be read out. These are located in the sub-level of block 82 in order from most to least recent. When a ninth fault occurs the data of the least recent fault are erased. Each of the eight fault buffers can hold up to 30 single indications. If more indications occur, the 30th indication will alarm that a buffer overflow has occurred.

It is not necessary to enter a code word.

The FAULT Annunciation block can be reached from the initial position when the device is in service by pressing the ▼ key twice. With the ► key the next operating level can be reached where block 82 can be accessed with the ▼ key. The last fault indication is reached by changing to the sub-level with the ► key. With the ▼ you can scroll to the less recent faults in this level.

A fault annunciation is defined such that a primary system fault is treated as *a single* system disturbance up to its ultimate clearance. Several faults may occur within a system fault (from the first fault detection of a protective function until drop off of the last fault detection).

If the date and time of the device have not yet been set (see also section 6.3.1.2), the date 01.01.98 appears, the time that appears is a relative time since the last start of the system processor. This is followed by the fault events in chronological order of their detection with a relative time referring to the time the fault began.

All available fault events are specified below. Of course only the relevant events appear in the display in the case at hand.

First, a few typical examples of fault events of a system fault with explanations of the display lines are shown.

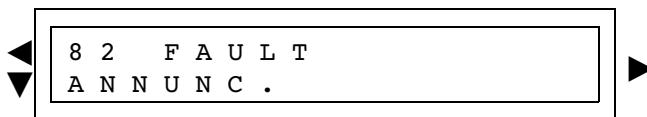

[5200]

Start of the block "Fault events"



[5210]

Start of the block "last fault events"

6 Operating Instructions

The buffer section shown in the display is selected line by line with the arrow keys ▼ and ▲:

▼
▼
0 3 . 1 1 . 9 8
2 2 : 0 9 : 4 6

▲
▲
▼
▼
. 8 1 0 m s
F a u l t

▲
▲
▼
▼
2
0 m s

▲
▲
▼
▼
0 m s
D e v . A c t .

[5211]

1st line: Date of last fault
2nd line: Time of the last fault
(hours, minutes, seconds)

and in ms)
Fault with coming tag

1st line: Fault number
2nd line: Start of the relative time

Start of relative time
Event that started the relative time

General fault events of the device

A N N o v f l (0115)

Fault annunciation buffer overflow (C)

S y s . F l t (0301)

Fault in the power system (C)

F A U L T (0302)

Flt. event w. consecutive no. (C)

F T d e t (0501)

General fault detection of device (C/G)

D E V . T r p (0511)

General trip of device (C)

Fault events of the differential function

I l =	Interrupted current : l1	(C)
D l y . s t . (3021)	Differential protection : IDIFF> time delay started	(C/G)
D i f . f l t (3022)	Differential protection : General fault detection	(C/G)
B l o c k . S (3024)	Differential protection : Blocked by external fault	(C/G)
B l o c k . H (3026)	Differential protection : Blocked by harmonics	(C/G)
D i f . T R P (3027)	Differential protection : Trip by IDIFF>	(C)
I n t T r p (3028)	Differential protection : Intertrip send signal	(C/G)

Fault events of the intertrip/transfer trip receiver

R e c . f l t (3346)	Trip receiver : General fault detection	(C/G)
R e c . T R P (3347)	Trip receiver : General trip	(C)

Fault events of the emergency overcurrent protection

E M E . F l t (2061)	Emerg. O/C prot.: General fault detection	(C/G)
E M E . T R P (2141)	Emerg. O/C prot.: General trip	(C)

6

Operating Instructions

Other entries

T a b . e m p t y

means that no fault is stored yet

T a b . f u l l

means that other fault data have occurred but the memory is full

T a b . E n d

If not all event recording memory is used, "Tab.End" is given as the last entry

The third operating level is reached with the ◀ key. The **last but one** system disturbance is reached by pressing the arrow key ▼. The individual fault events can be selected with the ▶ key in the fourth opera-

ting level and scrolled by means of ▼ and ▲. The possible events are the same as in the last system disturbance.

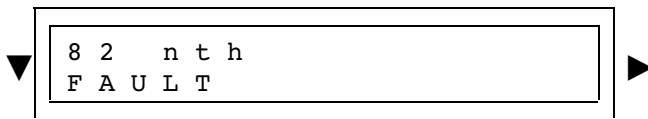

[5220]

Start of the block "last but one system disturbance"

The **third last** to **eighth last** system disturbance is reached in the same way. The possible events are the same as in the last system disturbance.

6.4.4 Reading out operational measured values - block 84

Operational measured values can be displayed in block 84. From the initial position of a relay that is in service, the block MEASURED VALUES is reached by pressing the ▼ key twice. With the ► key the next operating level is reached and from here, by scrolling with the ▼ key block 82 can be reached. The individual measured values can be found by changing to

the sub-level with the ► key. There is no need to enter a code word.

The values are displayed in percent of the rated variables. The prerequisite for correct display is that the specified ratings in block 00 (see section 6.3.3) have been correctly parameterized. The values are not updated during read-out. The current values are displayed after scrolling with ▼ or ▲ within the block.

The values given in the boxes below are examples. The current values actually appear here.

▲ 84 MEAS. ▼
▲ VALU E S ▼

[5700]

Start of the block "Operational measured values"

▲ I 1 = ▼
▲ 7 2 % ▼

The extract of the buffer shown in the display is selected line by line with the arrow keys ▼ and ▲:

The percentages specified for I_1 and I_2 refer to the primary or secondary rated current of the current transformer.

▲ I 1 = ▼
▲ 3 2 0 A ▼

The percentages specified for I_D and I_R refer to the rated current of the line.

▲ I 2 = ▼
▲ 7 3 % ▼

I_1 : Local measured current

I_2 : Remote calculated current

I_D : Calculated differential current

I_R : Calculated stabilization/restraint current

▲ I 2 = ▼
▲ 3 3 0 A ▼

▲ I D = ▼
▲ 2 % ▼

▲ I R = ▼
▲ 1 4 5 % ▼

6

Operating Instructions

6.5 Operational control capabilities

During operation of the device, interventions are possible with which individual functions and indications can be influenced. This includes above all the correction of date and time, as well as the switching on and off of sub-functions for operational reasons.

Switching on and off of sub-functions on the control panel or through the operator interface or by binary inputs is described at the beginning of each of the sections 6.3.4 to 6.3.7.

A prerequisite for control by binary inputs is that the appropriate control functions are marshalled and con-

nected to binary inputs when the device is installed (cf. section 5.5.2 Marshalling the binary inputs).

The block "ADDITION FUNCTION" is available for controlling with the control panel or the operator interface. This block can be reached from the initial position in a device that is in service by pressing the ▼ key three times.

When operating via a PC and the operating program DIGSI® the control addresses are identified by a four-digit address number. This is indicated in square brackets with the explanation text in the following representations.

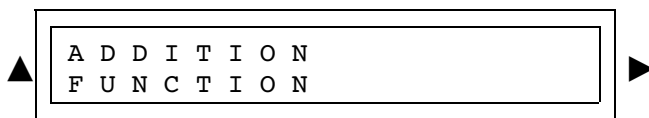

[9000]

Start of the block "Additional functions"

6.5.1 Setting date and time

With the ► key the next operating level (Block "TIME SETTING") can be reached. By changing the level again with ► the date and time can be read out initially. By scrolling with ▼ the operating blocks for setting the date and time are called as shown below.

After the device starts up the date 01.01.98 appears initially if it has not already been corrected and the time as a relative time since the last system processor start.

There is no need to enter a code word to change the date and time. Starting from the default setting the day, month and year are set by pressing the "+" or "-" keys.



Note

When entering the day, a maximum number of 31 days is assumed so that this value can be selected in all cases. The device only recognizes whether the input is plausible after the month and year (leap year or not) have been entered. After pressing the Enter key **E** automatic limiting to a valid date takes place.

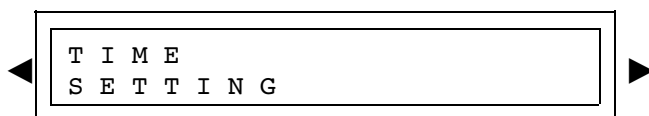

[8100]

Start of the block "TIME SETTING"

0 1 . 0 1 . 9 9
0 1 : 1 5 : 0 6

[8101]

First the "current" date (**DD. MM.YY**) and the current time (**HH:MM:SS**) are displayed. The actual setting blocks may be reached with ▼.

D A T E
2 7 . 1 0 . 9 9

[8102]

A new date can now be entered. This is done in the order: day, month, year **DD ► MM ► YY**

Starting at the default value the day is increased to the current date by pressing the "+" key. The ► key is pressed to reach the month. By pressing the "+" key, the month is increased until the current month is reached. Then the year is selected with the ► key, and increased with the "+" key until the current year is reached. The values can be decreased with "-". Finally the whole date input is confirmed by pressing the Enter key **E**.

T I M E
1 3 : 4 4 : 2 7

[8103]

To switch from the date setting to the time setting, ▼ is pressed. A new time can now be entered. This is done in the order: hours, minutes: **HH ► MM**

Starting from the default value first the hour is increased to the current hour by pressing the "+" key. Then change to the minutes by pressing the ► key and increase the minute to the current value with "+". The values can be decreased with "-".

There is no need to set the seconds. The seconds are automatically set to zero when the time input is confirmed.

The complete time input is confirmed and becomes active on pressing the Enter key **E**.

6.6 Testing and commissioning

6.6.1 General

Before commissioning, the preparations for putting the device into service as stipulated in chapter 5 must be completed.



Warning

During service, some parts of electrical devices are inevitably under dangerous voltage. This may cause serious personal injury or material damage to equipment if not handled professionally.

Only qualified personnel should work on this device. This personnel must be familiar with the pertinent safety regulations and the warnings in this manual.

Above all it should be observed:

- The device must be earthed at the PE terminal before making any connections.
- Dangerous voltages may occur in all circuit parts connected with the power supply and with the measuring and test circuits.
- Dangerous voltages may still exist in the device even after it has been disconnected from the supply voltage (charged capacitors).
- The permissible threshold values specified under Technical data may not be exceeded even during service testing and commissioning.

When testing the device with secondary test equipment, make sure that no other signal sources are connected and the trip commands to the circuit-breakers are interrupted.



Danger

The secondary connections of the current transformers must be short-circuited before the CT secondary connecting cables to the device can be disconnected!

If there is a test switch which automatically short circuits the current transformer secondary connection, it is sufficient to turn this to the "Test" position providing that this CT short-circuit has been tested beforehand (section 5.2.4).

It is recommended to test the device with the current settings applied. If these are not (yet) available, the default values should be used for testing. The following description of the test sequences assumes that the default settings are being used.

A symmetrical power source with individually controllable currents is assumed for the function test. A single-phase test current source is sufficient for the pick up test.



Note

The measuring accuracy which can be achieved depends on the electrical data of the test sources used. The accuracies specified in the technical data can only be expected if there is compliance with the reference conditions according to VDE 0435/part 303 or IEC 60255, and use of precision measuring instruments. Tests with secondary test equipment are therefore generally considered as pure function tests.

It is important for all tests that the appropriate indications are given by the LEDs and by the signal relays for remote signaling.

Following tests which initiate indications via the LEDs, these should be reset via the reset pushbutton on the front panel (button N) and via binary input for remote resetting (if this is marshalled). Once via binary input and once via pushbutton is sufficient. After the reset functions have been checked, the displays need not be reset after every test because they are reset automatically with every protection activation and replaced by the new indication state.

6.6.2 Checking the line differential protection

To test the differential protection function, it must be activated, i.e. DIFFPROTECTION (addr. **10 DIF.PR**) to ON. The pilot wire monitoring must be switched off (addr. 1601 **11 PL.MON** = OFF).

To test the local threshold of **10 DIFF>** the pilot wires are shortcircuted behind the relay. Be shure, that 01Rx the pilot wire loop resistance is set to zero in the relay for this test condition.

Better is to test the configuration together with the pilot pair. When testing a pair of devices the pilot wires of both devices are connected to each other with swapped polarity. Please check, if the parameter 01Rx is set according the pilot wire resistance (s. 6.7.2). Both devices must be connected to auxiliary supply voltage. In this case the second device can run without a test current (corresponds to the simulation of a single-end fed line short-circuit), or the test current is fed through both devices, in phase (internal short-circuit) or reversed phase (external short-circuit).

When evaluating the currents, note that the current processed by the differential protection is dependent on the connection of the summation transformer and the parameters **01 IN LN.** and **01 IctPRI**. For the test current injection, an "ideal" current source must be used.

The following applies:

$$I_P = I_M \cdot N_{MW} \cdot N_{Par} \cdot N$$

with

- N - 1 for 1 A device, 5 for 5 A device
- I_P - test current,
- I_M - setpoint to the relay

N_{MW} - transformation factor summation transformer,
 N_{Par} - transformation factor of the parameters.
 IN LN./IctPRI

Symmetrical three-phase test current and standard connection of the summation transformer according to Figure 5.3 $N_{MW} = 1$; at default setting of the device $N_{Par} = 1$ also.

For testing with single-phase current, table 6.1 specifies the factors N_{MW} depending on the winding on which the current is injected.

Table 6.1 Current factors for summation transformers

Winding (factor)	Summation transformer connection	bridged terminals	N_{MW}
1	A-F	B-E	1.73
2	C-H	D-G	0.87
3	L-M	-	0.58
6 (all in series)	A-M	B-C D-E F-G H-L	0.29

The parameter factor results from

$$N_{Par} = \frac{I_{N, line}}{I_{N, CT}}$$

with

$I_{N, line}$ - primary rated current of the line, as parameterized under addr. **01 IN LN.**

$I_{N, CT}$ - primary rated current of the current transformers, as parameterized under addr. **01 IctPRI**.

Example:

Rated current of the device $N=1$ A; parameter **10IDIFF>** = 0.5 $I_n = I_M$; current factor for summation transformer $N_{MW} = 0.87$ (Table 6.1 - Summation transformer connection C-H, bridged terminals D-G); rated current of the line (parameter **01 IN LN.**) - 500 A; primary rated current of the main current transformer (parameter **01 IctPRI**) - 1000 A.

6

Operating Instructions

Test current I_p at the summation transformer input terminal C-H for testing the parameter **10 IDIFF**:

$$I_p = I_M N_{MW} \cdot N_{par} \cdot N = 0,5 \cdot 0,87 \cdot \frac{500}{1000} \cdot 1 = 0,2175 \text{ A}$$



Caution

Tests with currents above four times the device rated current lead to overloading of the input circuits and may only be applied for short periods (see Technical data, chapter 3). Then a pause to allow the device to cool down must be allowed!

The thermal load capacity limit applies both for the individual input windings of the summation transformer and for the output current of the summation transformer.

When using single-phase current injection, and a winding factor which is greater than 1, the thermally permissible current is reduced by the factor N_{MW} (Table 6.1). If, on the other hand, a winding factor of 1 applies, the thermally permissible current is not increased!

Switch the test current to 1.2 times the setting value **10 IDIFF** and 1.2 times the setting value **10 I1REL**; both values must be exceeded. A trip signal is output. Check closing of the command contacts and the trip indication contacts.

If a delay time is parameterized for the trip (addr. **10 T-DLY**), the trip command appears delayed accordingly.

6.7 Commissioning with primary measured signals

Before the line is energized, all secondary testing equipment must be removed. The preparations for putting the device into service as described in section 5.2 must be completed. The line must be energized for the primary tests.



Warning

Primary tests may only be performed by qualified personnel who are familiar with the commissioning of protection systems, operation of the network and the safety rules and regulations (switching, earthing, etc.).

Rapid commissioning without instrumentation is possible using the integrated measuring functions and commissioning tools in the device.

The line is initially open and earthed at both ends at the beginning of the measurements for the commissioning.

Initially, the differential protection is switched to *AL-Only* (addr. **10DIF.PR**) or the trip command is interrupted; the pilot wire monitoring (if available) is switched *OFF* (addr. **11PL.MON**). The function tripping by remote station (addr. **13TR.REC**) is also initially switched off.

The differential protection can generally be activated in two ways.

- Protective function *AL-Only*: The protective function operates and outputs indications. The trip command is blocked however.
- Protective function *ON*: The protective function operates and outputs indications. The trip command goes to the trip relay which has been marshalled with the protective function according to section 5.5.5. No tripping takes place if the protective function is not marshalled to any trip relay.

6.7.1 Checking the switching states of the binary inputs/outputs

The differential protection 7SD600 contains a test program with which the switching states of all binary inputs and outputs can be polled and shown in the display.

Tests are available from block 40. The **ADDITIONAL FUNCTIONS** block can be reached from the initial position of a device in service by pressing the ▼ key three times. The **DATE/TIME** block can be reached by changing to the next level with ►. The **Tests** block can be reached with ▼.

When operating via a PC and the operating program DIGSI® the test addresses are identified by a four-digit address number. This is indicated in square brackets with the explanation text in the following examples.

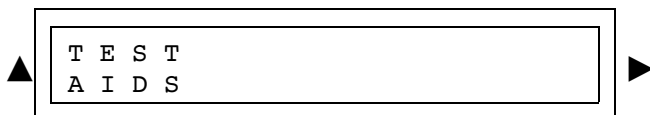

[4000]

Start of the block "Tests"

6

Operating Instructions

Changing to the next block with **▶** leads to the block Testing the switching states of the inputs/outputs.

Changing again with **▶** leads to testing the switching states of the binary inputs.

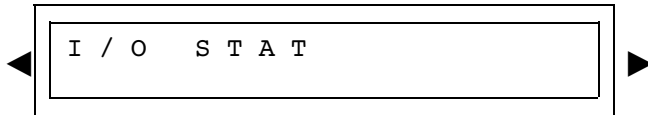

[4100]

Block "Testing the switching states of the inputs/outputs"

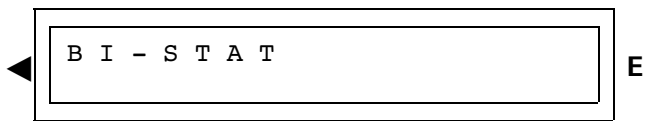

[4101]

Block "Testing the switching states of the binary inputs"

After pressing the Enter key **E** the operator is asked whether the status enquiry is to be performed for the binary inputs. In the case of a negative response, the

test is canceled and the next test item may be selected with **▼**.

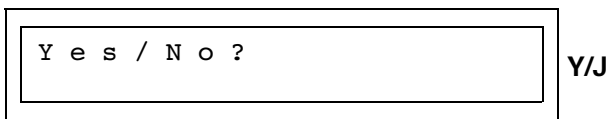

On pressing the **Y/J** key the switching state of the three binary inputs (BI) is displayed in the form of a matrix. The definitions are as follows:

- 1: BI 1 is activated (voltage applied)
- 2: BI 2 is activated (voltage applied)
- 3: BI 3 is activated (voltage applied)
- : The corresponding BI is not activated

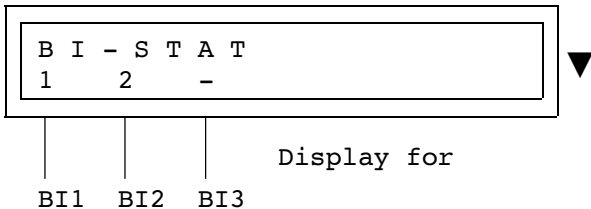

In this example, the binary inputs 1 and 2 are activated, BI 3 is not under voltage.

With **▼** you change to testing the switching states of the indication and command relays:

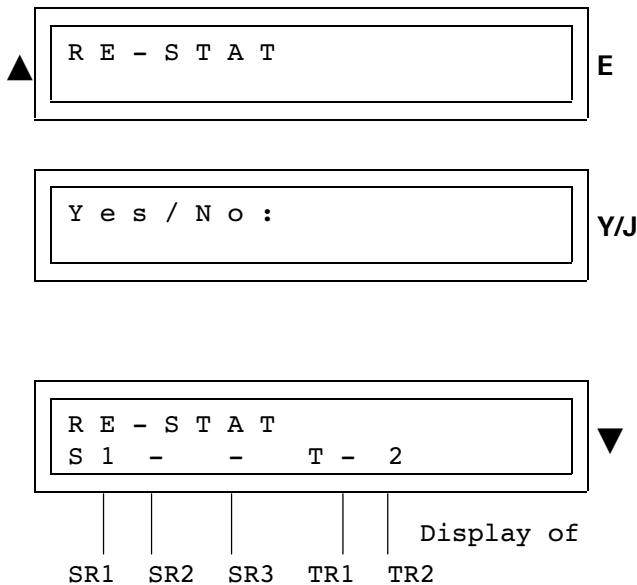

[4102]

Block "Testing the switching states of the relays"

After confirming with the Enter key **E** a question is asked which can be answered with Yes or No. On pressing the **Y/J** key the switching state of the 2 signal relays and the 2 trip relays is displayed in the form of a matrix. The meanings are as follows:

- 1: Indication of signal relay 1 is energized
- 2: Indication of trip relay 2 is energized
- : The corresponding relay is not energized

In this example, the signal relay SR1 and the command relay KR2 are closed, indication relays SR2, SR3 and trip relay TR1 are **not** energized.

With ▼ testing the switching states of the LEDs is reached:

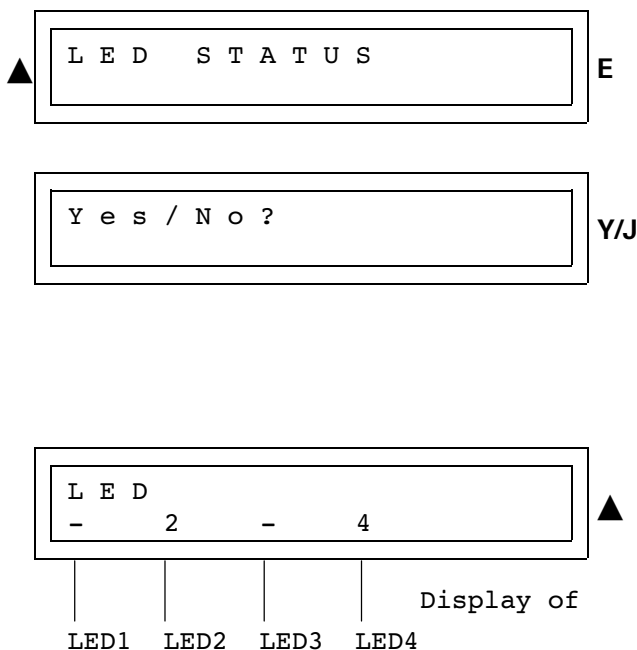

[4103]

Block "Test LED status"

After confirming with the Enter key **E** a question is asked which can be answered with **Yes** or **No**. On pressing the **Y/J** key the switching state of the 4 LEDs is shown in the form of a matrix. The meanings are as follows:

- 1: LED 1 light on
- 2: LED 2 light on
- 3: LED 3 light on
- 4: LED 4 light on
- : The corresponding LED light is off

In this example, LED 2 and LED 4 are on and LED 1 and LED 3 are off.

6

Operating Instructions

6.7.2 Measuring and setting the pilot wire resistance

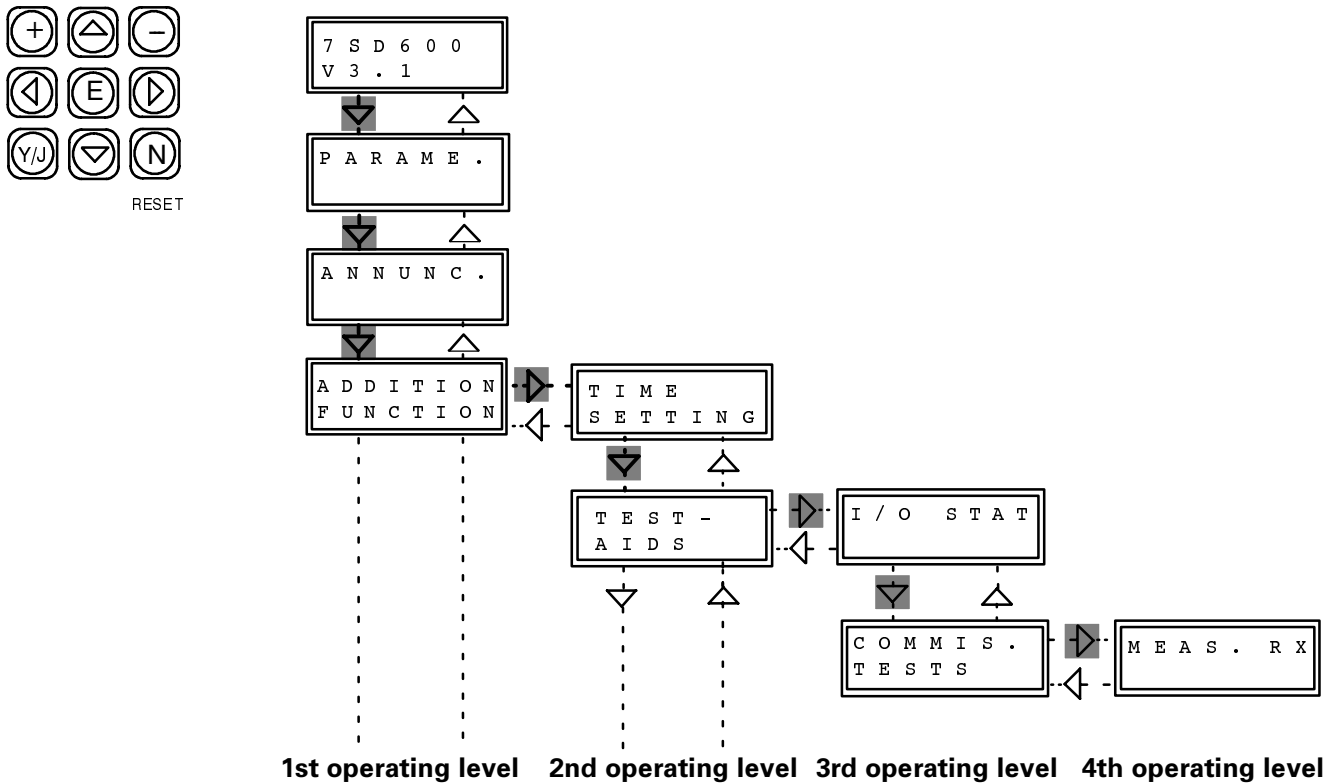

Figure 6.6 Measuring of the pilot wire resistance

For this measurement the differential function **10 DIF.PR=OFF** and the pilot wire monitor **11 PL.MON=OFF**. Otherwise the relay picks-up and trips and don't allow the measurement for that.

In the two-wire differential protection the operating principle requires adjustment of the resistance ratio between the pilot wire resistance R_a and the shunt connected resistor in the relay R_b installed in the device. In the 7SD600, external resistances to adapt the pilot wire resistances are not required, as the device provides internally computed adaptation. To do this it must know the pilot wire resistance (addr. **01 Rx**).

The loop resistance of the pilot wires can be calculated from the specification data of the pilot wire or should better be measured by the device itself. To execute the pilot wire resistance measurement, the two 7SD600 relays must be connected to the pilot wire pair at their respective line ends.

To make the measurement, a current corresponding to at least 2 x the device rated current is injected in at one end. The current can be fed into the summation transformer as a secondary current. The connection type of the measuring current at the summation transformer must be taken into account when assessing the current value. The current must remain constant during the measurement.

The resistance measurement can be requested under addr. **MEAS.Rx**. The device-internal resistors in the pilot wire path (Figure 4.1, Figure A.1): $R_a = R_b = 220 \Omega$.

▲ TEST
AIDS ▲

◀ I / O S T A T ▼

◀ C O M M I S .
T E S T S ▲

◀ M E A S . R x E

Y e s / N o ? Y/J

M E A S . R x
R x = 5 6 6 Ω

F A U L T

I t o o s m .

[4200]

Start of the block "Commissioning tests"

[4201]

Start of the block "Measuring the pilot wire resistance"

After you have reached the 4th operating level, by pressing the enter key **E** and confirming the question **Yes/No** mit **Y/J** the measuring is of R_x is initiated. The device determines the loop resistance from the voltage generated by the measuring current at the shunt resistance and the current flowing through the pilot wires.

The jumper has to be plugged according to the measured value, see Appendix A.2.

The resistance is usually output immediately after tripping the resistance measurement. However, if there is already a fault detector picked up, the resistance measurement cannot be made and an indication to this effect appears on the display. At low current the indication "**I too sm**" appears.

Display of the measured pilot wire resistance (resolution 1 Ω, e.g. 566 Ω)

Pick up condition

The injected measuring current or the pilot wire current I_a is not sufficient to determine the pilot wire resistance. Make sure that the pilot wires are connected at both ends.

6

Operating Instructions

The measurement is terminated automatically when the resistance is calculated by the relay.

The determined pilot wire resistance must be set in addr. **01Rx** as Rx, see Chapter 6.3.3 [1131]. The resistance of a pilot wire monitoring, if it exists, is included

6.7.3 Checking the current transformer termination

The current transformer termination is checked with primary measured signals. A load current of at least 25 % of the rated line current is necessary for this.

This check cannot replace the visual check of the correct current transformer termination because the result of the measurement with the summation CT current does not always uniquely identify the cause of the error. For instance, a connection with incorrect phase rotation due to swapped phase or with incorrect phase allocation but still maintaining the correct phase rotation cannot be detected! Same connection error at both line ends The checks according to section 5.2.5 are therefore a precondition.

Secondary test equipment connected for the previous tests and measurements must be removed. The summation transformer must be connected to the current transformer.

Before switching on the line, make sure that a short-circuit protection is available at both ends of the line.

The differential protection functions remain switched to *ALRonly* (addr. **10 DIF.PR**).

- Open earth switches of the line. Connect line both ends. It must be ensured that at least 25 % of the rated line current flows through the line. If necessary, changes in the system configuration must be implemented. The direction of the current is irrelevant.
- The summation transformer secondary current can be measured in the operational measured values under addr. **84 MEAS.VALUES**. If connected correctly this value corresponds to the current flowing through the line, in relation to the rated current of the device or the primary rated current in A.

If matching transformers are connected, their actual transformation ratio must be taken into account.

ded in the displayed value and special allowance does not need to be made for this. The setting must be made at both ends of the line. Measurement from one end of the line is sufficient.

Current transformer terminations may still be swapped. Table 6.2 shows the measured current in relation to the expected current for polarity errors in the current transformer connection:

- Isolate and earth line.
- Correct current transformer connections.
- Repeat test.

Table 6.2 Measured currents with incorrect CT connection

measured I/I_{expected}	possible correction error
4,36	Transformer L2, incorrect polarity <i>or</i> Transformer L1 and L3, incorrect polarity
4,73	Transformer L3, incorrect polarity <i>or</i> Transformer L1 and L2, incorrect polarity
4.93	Transformer L1, incorrect polarity <i>or</i> Transformer L2 and L3, incorrect polarity
1.00	All transformers have incorrect polarity <i>or</i> incorrect phase rotation <i>or</i> incorrect phase allocation by correct phase rotation <i>or</i> right connection

On the one hand the table shows that the measured deviations only differ slightly in the case of reverse polarity of single phases which is why all connections must be checked again carefully in any case. On the other hand, swapped phases are not detected at all. This is basically irrelevant for the function of the differential protection provided that only the connections at both ends of the line are identical.

However, a uniform phase allocation is important for the sensitivity of the protection in the case of double earth faults in the non-earthed network.

Finally, switch off the line again.

The correct polarity of the earth current path (in standard connection according to Figure 5.3) is checked when current I_{L2} is missing (Figure 6.7):



Caution

Work on the current transformers requires the greatest caution! Short circuit current before disconnecting any CT connections to the device!

Current transformer phase I_{L2} is short-circuited at the CT and the connection cable to the summation transformer is disconnected. The previous load current test is repeated.

The current value I_1 read out is now about 2.65 times the current value in the symmetrical test.

If the measured current practically does not change in relation to the symmetrical test, the earth current connection on the device has incorrect polarity.

At other values there may be swapped phases:

- Isolate and earth line.
- Correct current transformer connections.
- Repeat test.

Finally, switch off the line again. **Correct the current transformer connection again.**

repeat the tests at the other end of the line.

For further checking of the current transformer and pilot wire connections with both line ends, the main current transformers of phase L2 are short circuited and disconnected in both stations, in this case, the stabilizing current I_S increases in the operational measured values. The differential current I_D must remain small. A reference value for this differential current can be calculated with the equation given at the end of chapter 6.3.4.

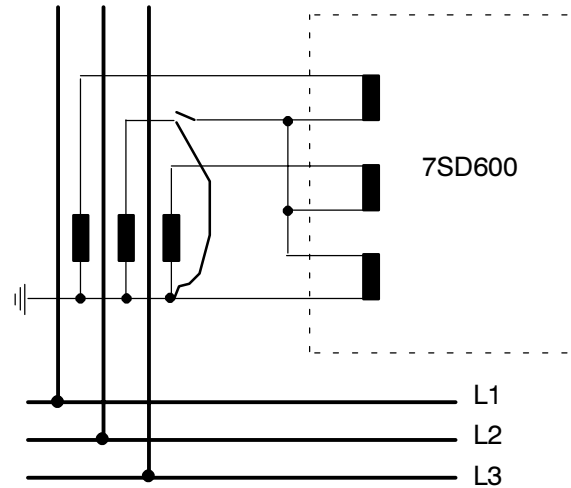

Figure 6.7 Checking the earth current path

6

Operating Instructions

6.7.4 Trip test with the circuit-breaker

The pilot wire protection 7SD600 allows simple testing of the circuit-breaker.

The block for testing this is located under the ADDITIONAL FUNCTIONS in the TESTS block. The TESTS block is reached as described in section 6.7.1. The I/O STAT block is reached by changing to the next level with ►. From here the circuit-breaker test is reached by pressing the ▼ key twice.

When operating via a PC and the operating program DIGSI® the test addresses are identified by a four-digit address number. This is indicated in square brackets with the explanation text in the following examples.

To test the trip circuits, the circuit-breaker may be operated by the 7SD600 irrespective of whether an automatic reclosure ensues or not. This test can also be performed with an external automatic switch on.

If the circuit-breaker auxiliary contact sends the position of the breaker to the device by a binary input, the trip test can only be activated if the circuit-breaker is closed. The input must be marshalled with

“CBclo”(F.no.1157). You should not ignore this added safety factor if an external autoreclosure is available.

You go to the operating block for the actual circuit-breaker tripping by changing to the next operating level with ►.



Danger

A successfully started test cycle can lead to switching on of the circuit-breaker if an external autoreclosure on is connected!

Precondition for starting the test is that no protective function of the device has picked up. A code word must also be entered. The tripping by the circuit-breaker test **1185 CBtpTST** must be programmed for the trip relay to be tested!

The device shows the respective state of the test routine in the second display line.

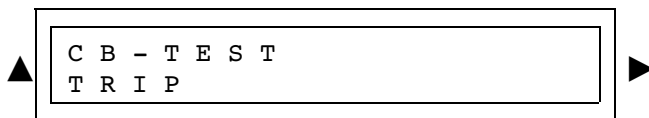

[4400]

Block "Circuit-breaker test tripping"

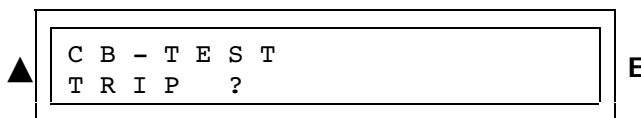

[4404]

With the key ► the following dialogue appears. After confirming with the Enter key **E** a prompt to enter the code word appears. After entering the code word (- + - key) and re-confirming with **E** a check is made whether a circuit-breaker test is allowed at present or whether this is prevented by one of the reasons mentioned above.

If there is no reason for its prevention, the circuit-breaker test takes place immediately.

6.7.5 Checking the transfer tripping (if available)

If transfer tripping by binary input is used, these functions must also be checked.

In the transfer tripping, activation of the appropriately marshalled binary input "**>Tr.TRP**" **Fno.3306** leads to transmission of a trip command to the remote end of the line. At the receiving end **ON** must be selected under addr **13 TR.REC**. After activating the appropriate binary input, tripping takes place at the other end of the line with the delay (addr. **13 TR.DLY**) plus the transmission time.

6.7.6 Checking the emergency overcurrent protection

This function must be checked, if **14 E.O/C** is not set to **OFF**.

The value of the test current I_p to check the pick-up threshold of **14 I1>EME** is calculated according chapter 6.6.2. The test current depends on three-phase test injection or single phase injection. For single phase injection table 6.1 shows the terminals and bridges at the summation transformer where to inject the test-current and also the transformation factor N_{MW} . Three phase test injection is recommended. Before injecting a test current, disconnect the pilot wire connection to the remote relay. The differential

function becomes inactive, if **11 DIF.BL** (Block differential function during pilot wire failure) is set to **ON** (factory setting). Also a pilot wire failure is detected indicated with LED3 (factory setting). Both functions therefore must switched on for this test (10 **DIF.PR=ON** and 11**PL.MON=ON**).

This allows to check the threshold of **14 I1>EME** either if **14 E.O/C** is set to **Flt.PWM** (activ with pilot wire failure) or **DIFinact** (activ, if differential function is inactive).

Inject a test current I_p , which exceeds the **14 I1>EME** threshold about 5%. An emergency overcurrent trip is indicated at the trip relays and shown as "**DEV.Trp**" **Fno. 511** at LED2 (in the standard marshalling). Note that the trip may be delayed with the time set in **14 T I1>**. Switch of test current I_p . The allowed time to inject the test current refers to table 3.12. Inject a test current I_p , which is about 95% of **14 I1>EME** threshold. The relay should not trip.

Example: Rated current of the summation transformer $N=5\text{ A}$; parameter $I_M = \mathbf{14\ I1>EME=1.5}$ of nominal current of the line; current factor for summation transformer $N_{MW}=1$ because of symmetrical test current injection in the standard connection; rated current of the line **01IN LN.=500 A**; primary rated current of the **CT 01IctPRI=1000 A**;

The symmetrical test current I_p at the summation transformers terminals for testing the function is:

$$I_p = N \cdot I_M \cdot N_{MW} \cdot N_{par} = 5 \cdot 1.05 \cdot 1.5 \cdot 1 \cdot \frac{500\text{A}}{1000\text{A}} = 3.94\text{ A}$$

In this case a test current of 3.56 A, which is 95% of threshold do not lead to a trip.

6 Operating Instructions

6.7.7 Resetting the Lockout state

When the Lockout function is switched on, this function can be reset with the keypad or with DIGSI even

if the parameter **01L.O.Re.** is set to BI (reset by binary input).

From the *TESTS* block, the *LOCK OUT RESET* block can be reached by changing to the next level with ▼.

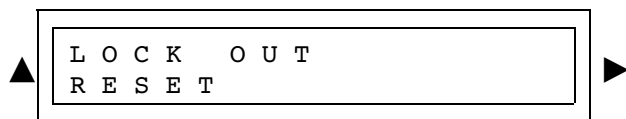

[4300]
Block "Lock Out Reset"

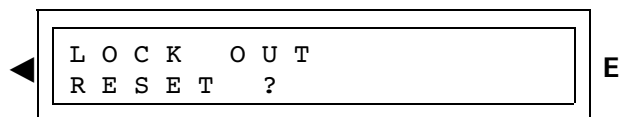

Prompt

After confirming with the Enter key **E** the operator is asked whether he wants to perform the function.

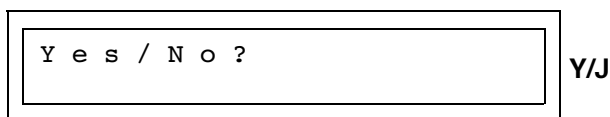

On pressing the **Y/J** key the Lockout function is reset.

6.8 Putting the protection into service

Check that the module is inserted properly and screwed in tightly. The green LED "Operation" must be lit, the red LED "Fault" may not be lit.

All terminal screws - even those not used - must be tight.

If a test switch is available, this must be switched to the service position.

The protection is now ready for operation.

The setting values should be re-checked if they were changed during the test. Check especially whether all protection and additional functions are set correctly in the configuration parameters (section 5.4, address blocks 00 and 01) and all desired functions are switched *ON*.

The displays on the front panel are cleared by pressing the "**N**" key so that these only provide information about real faults in future. When this key is pressed the marshallable LEDs on the front panel light up so that a LED test is also conducted.

7 Maintenance and Troubleshooting

Digital protection equipment has no special maintenance requirements. All measuring and signal processing circuits are provided by static circuits with no moving parts. All input modules are also static; the output relays have protective covers.

Since the device is largely self-monitoring, hardware and software errors are signaled automatically. This guarantees the high availability of the protection. Maintenance checks at short intervals are therefore unnecessary.

The device blocks automatically when it detects hardware errors; the relay "Protection in service" (if pro-

grammed) drops out and signals the error with its NCC.

Detected software errors initiate a processor reset and restart. If such an error is not eliminated by the restart, another restart attempt is made. The protection is automatically taken out of service after three unsuccessful restart attempts. This is indicated by the red "Fault" LED on the front panel; the signal relay "Device ready" drops out and signals the fault with its NCC.

The error reactions can be accessed under block 81 for error diagnostics in chronological order as operational events (see section 6.4.2).

7.1 Routine checks

Routine checking of characteristics or pick-up values is unnecessary because these are part of the continuously monitored firmware programs. The maintenance intervals planned for inspection and maintenance of the plant can be used to perform operational tests on the protection equipment. This results from the fact that maintenance serves above all to check the device interfaces, i.e. the link with the system. The following procedure is recommended:

- Read out the operational measured values (Block 84) and compare them with the actual values to check the analog interfaces.
- Simulate a short-circuit with 4 times I_N to check the analog input at high currents.



Warning

Dangerous voltages may occur in all circuit components connected to the power supply and the measuring and test signals.



Caution

Tests with currents greater than 4 times the rated device current lead to overloading of the input circuits and may only be conducted for brief periods (see Technical data, section 3.1.1). Subsequently, a break for cooling should be made!

- The trip circuits for the circuit-breaker are checked by tripping the circuit breaker under load. See section 6.7.4 for information.

7.2 Troubleshooting

If the device reports a failure, the following procedure is recommended.

If none of the LEDs on the device's front panel light up, check:

- Is the module inserted correctly and secured tightly?
- Is the auxiliary supply voltage high enough and connected to the correct terminals with the correct polarity (overview diagrams in appendix A)?
- Is the fuse in the module's power supply unit undamaged (see Figure 7.1)? Replace the fuse as described in section 7.2.1 if necessary.

If the red fault LED lights up and the green standby LED is dark, try to initialize the protection by turning the auxiliary supply off and back on.

However, in this case, parameter values which have not been saved during a parameterization process may be lost. The date and time must also be updated (see section 6.5.1).

7.2.1 Changing the fuse

- Keep spare fuse 5 x 20 mm as shown in Figure 7.1 at the ready. Make sure it has the correct rating, speed (T) and code letter.
- Prepare the working surface: Create a conductive surface to place the module on.
- Push back the two covers located at the top and bottom of the front cover; this gives access to two centrally located screws. Loosen these two screws.



Warning

Dangerous voltages may still be present in the device (charged capacitors) even after disconnecting the power supply or removing the module!

- Hold the module by the front cover, pull it out and place it on the conductive surface;



Caution

It is absolutely essential to avoid electrostatic discharge through the component terminals, conductors and plug pins by touching earthed metal parts beforehand.

- Remove the defective fuse from the holder (Figure 7.1).
- Insert new fuse in the holder as shown in Figure 7.1.
- Insert module in the housing;
- Secure the module in the housing by tightening the two screws in the front cover

Switch the device back on. If auxiliary supply failure is still signaled, there is an error or short-circuit in the internal power supply. The device should be sent back to the factory (see chapter 8).

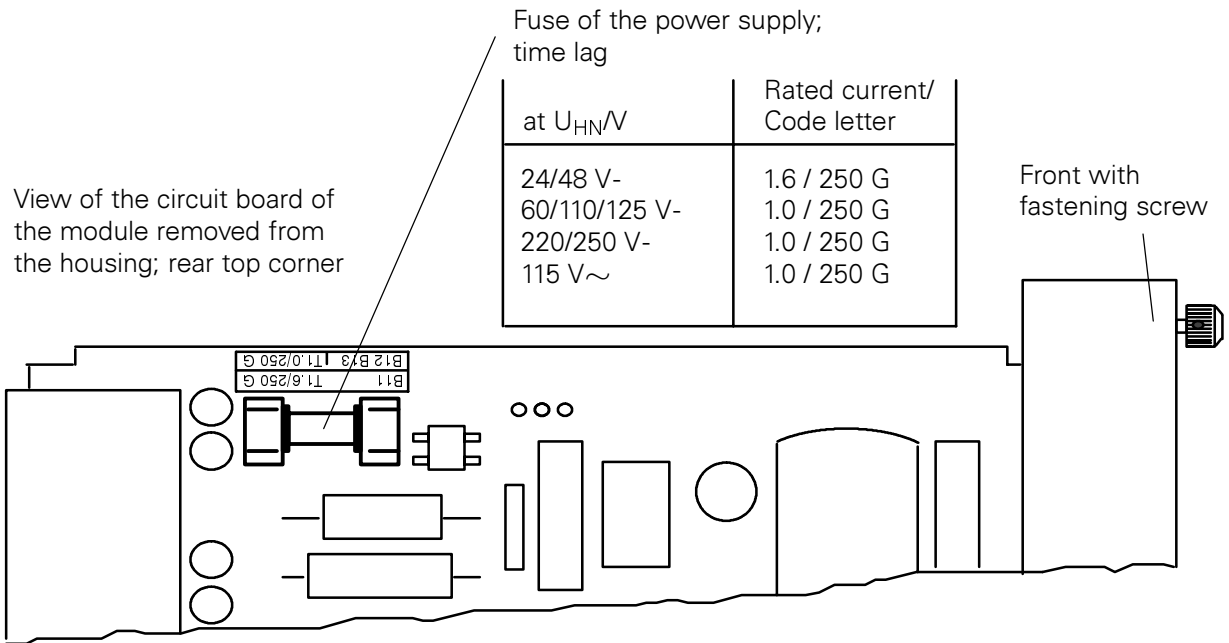

Figure 7.1 Fuse of the power supply

8 Repairs

It is strongly recommend not to repair defective devices or modules because specially selected electronic components are used which must be handled in accordance with the directives for ESD (**E**lectrostatically **S**ensitive **D**evelopments). Special manufacturing techniques are also necessary for working on the circuit boards to avoid damaging the wave-soldered multilayer boards, the sensitive components and the protective coating.

Therefore, if a defect cannot be eliminated by operating measures as described in chapter 7, it is advisable to return the whole device to the manufacturer. Use the original transport packaging if possible. If other packaging is used, it must comply with the shock-proofing requirements according to IEC 60255-21-1 Class 2 and IEC 60255-21-2 Class 1.

If replacement of individual modules is unavoidable, the ESD regulations must be observed (handling electrostatically sensitive devices).



Warning

Dangerous voltages may still occur in the device (charged capacitors) even after disconnecting the power supply or removing the module!



Caution

It is absolutely essential to avoid electrostatic discharge through the component terminals, conductors and plug pins by touching earthed metal parts beforehand. This also applies when replacing components in sockets such as EPROM or EEPROM components. Use electrostatically protected packaging to return to the factory.

The modules are not at risk when they have been installed in the device.

Complete re-parameterization may be necessary after replacing devices or modules. Information about this can be found in the chapters 5 and 6.

9 Storage

The devices must be stored in dry, clean rooms. The temperature range -25 to +55 °C (see chapter 3 under Technical data) applies for storing the device or its spare modules.

The relative humidity may not cause condensation or ice.

It is recommended to maintain a restricted temperature range between +10 and +35 °C to prevent premature ageing of the electrolytic capacitors used in the power supply.

Approximately every two years, it is recommended to connect the device to an auxiliary supply for 1 or 2

days to format the electrolytic capacitors used in the power supply. This should also be done when it is planned to use the device. This also has the effect of "warming up" the device and avoiding moisture condensation under extreme climatic conditions (tropical).

Before connecting the device to the power supply for the first time, it should be placed in the control room for at least 2 hours to balance the temperature and avoid moisture and condensation.

A.1 Overview diagram

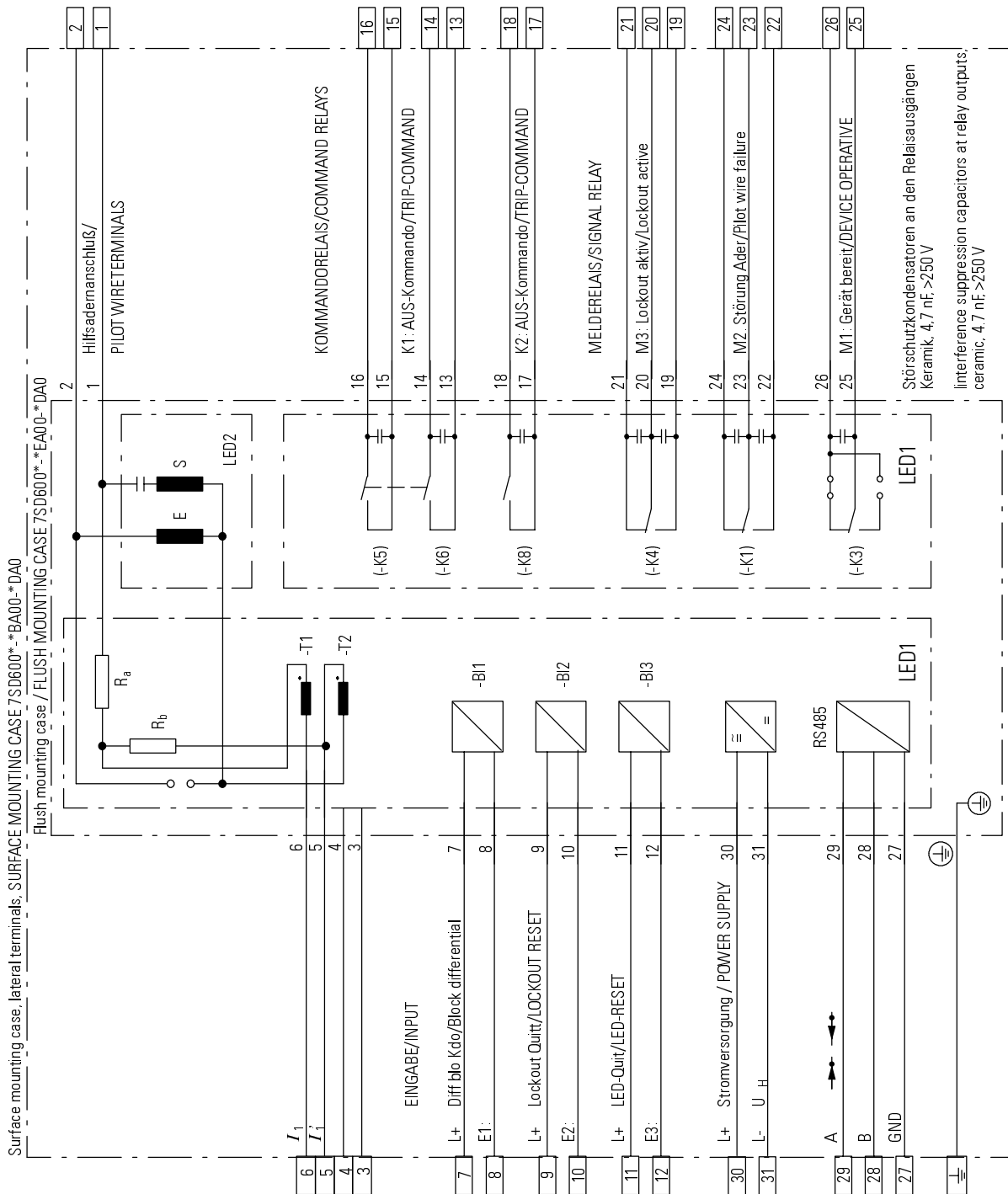

Figure A.1 Overview diagram of the differential protection 7SD600*.*B*** and 7SD600*.*E***.

A

Appendix

A.2 Jumper position of R_x (Setting of the sensitivity of the pilot wire monitor)

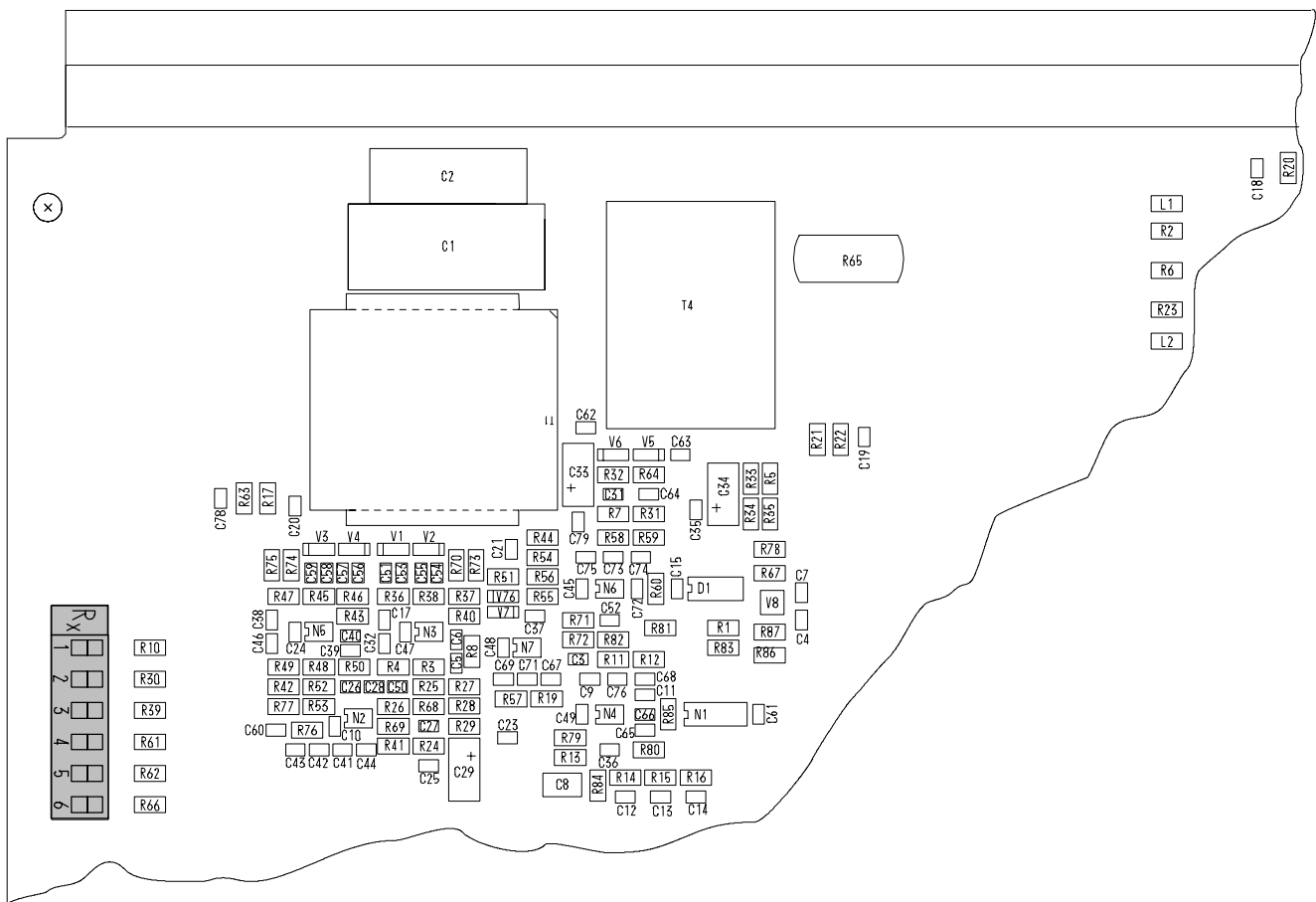

Figure A.2 Position of the jumper section of R_x

In delivery the jumper R_x is plugged on position 6.

After you have determined the pilot wire resistance R_x according to chapter 6.7.2 and have entered it according to chapter 6.3.3, plug the jumper in both relays according to the table in the margin.

determined pilot wire resistance R_x	jumper
< 200 Ω	1
200 Ω ... 400 Ω	2
400 Ω ... 600 Ω	3
600 Ω ... 800 Ω	4
800 Ω ... 1000 Ω	5
1000 Ω ... 1300 Ω	6

A.3 Connection diagrams

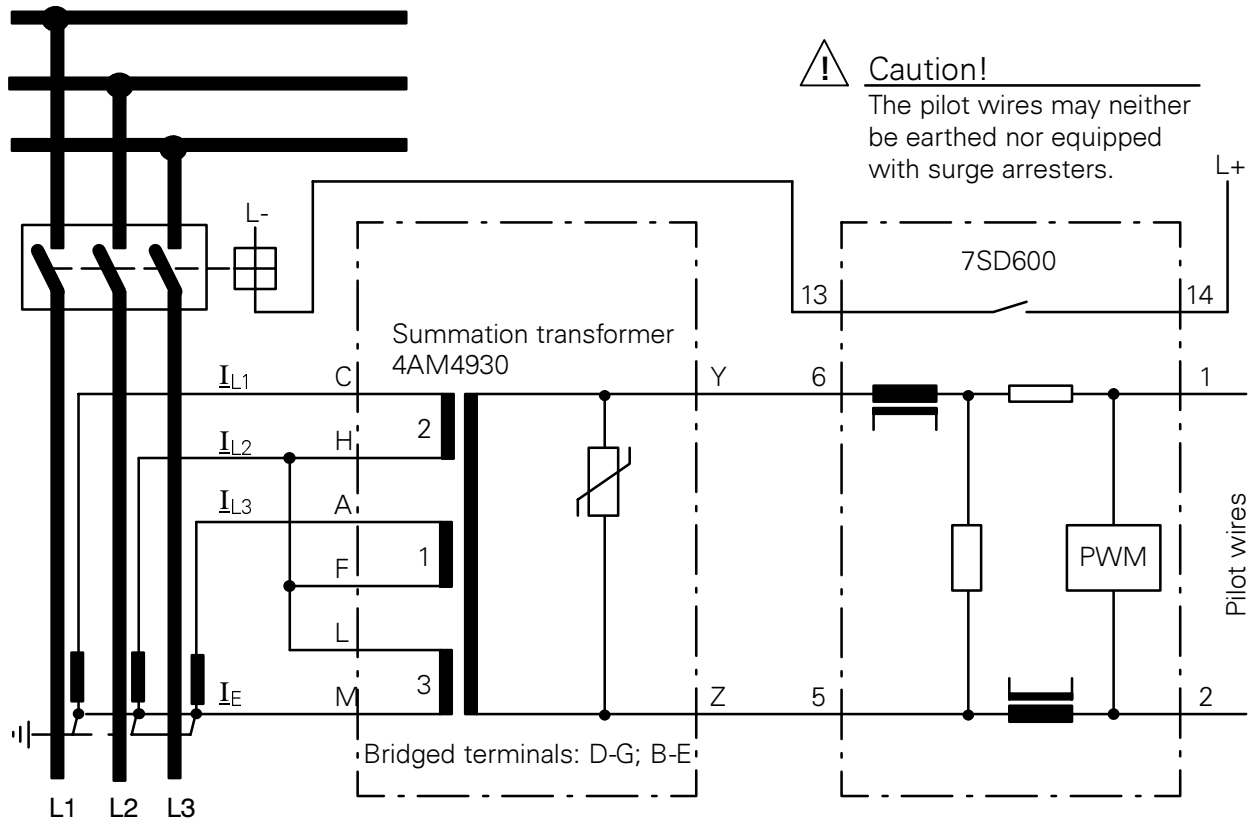

Figure A.3 Standard connection L1-L3-E, suitable for all networks

A

Appendix

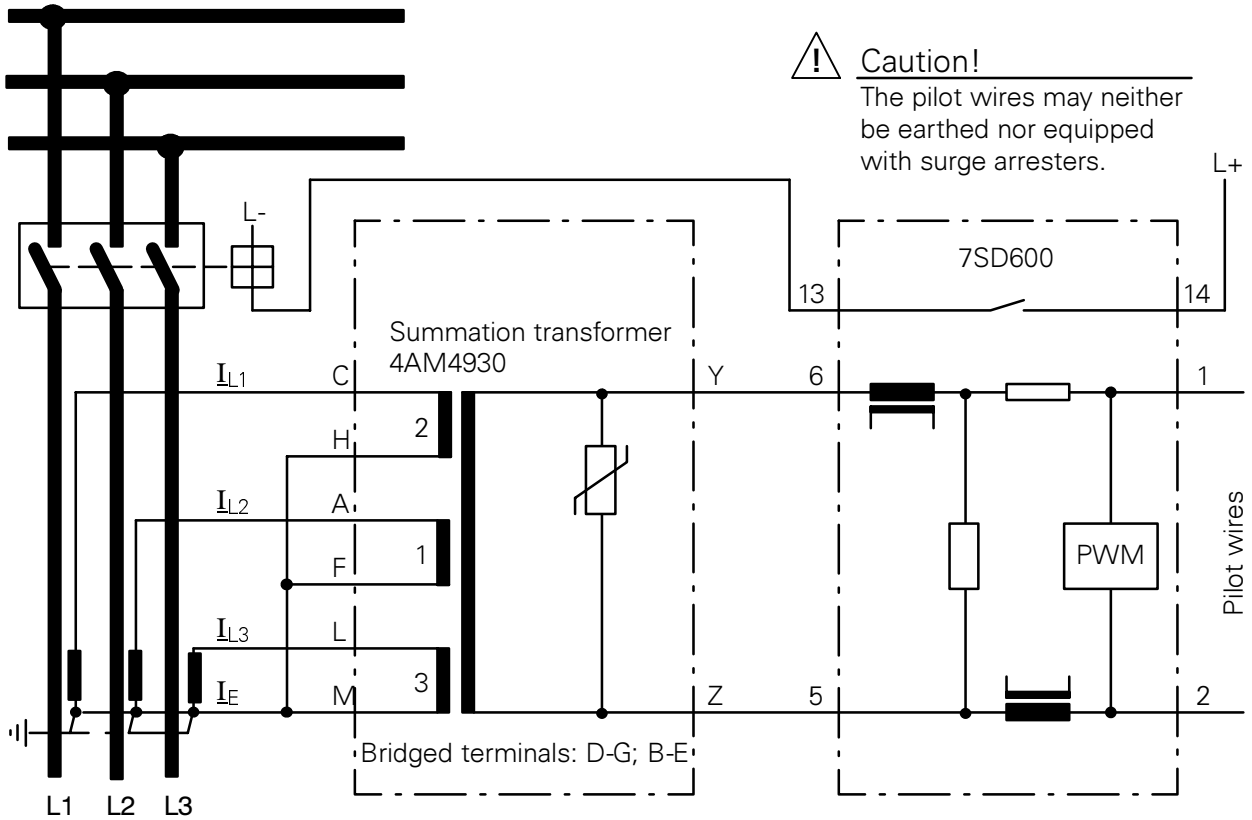

Figure A.4 Connection L1-L2-L3 with reduced earth-fault sensitivity, preferable for effectively earthed networks with particularly low zero sequence impedance

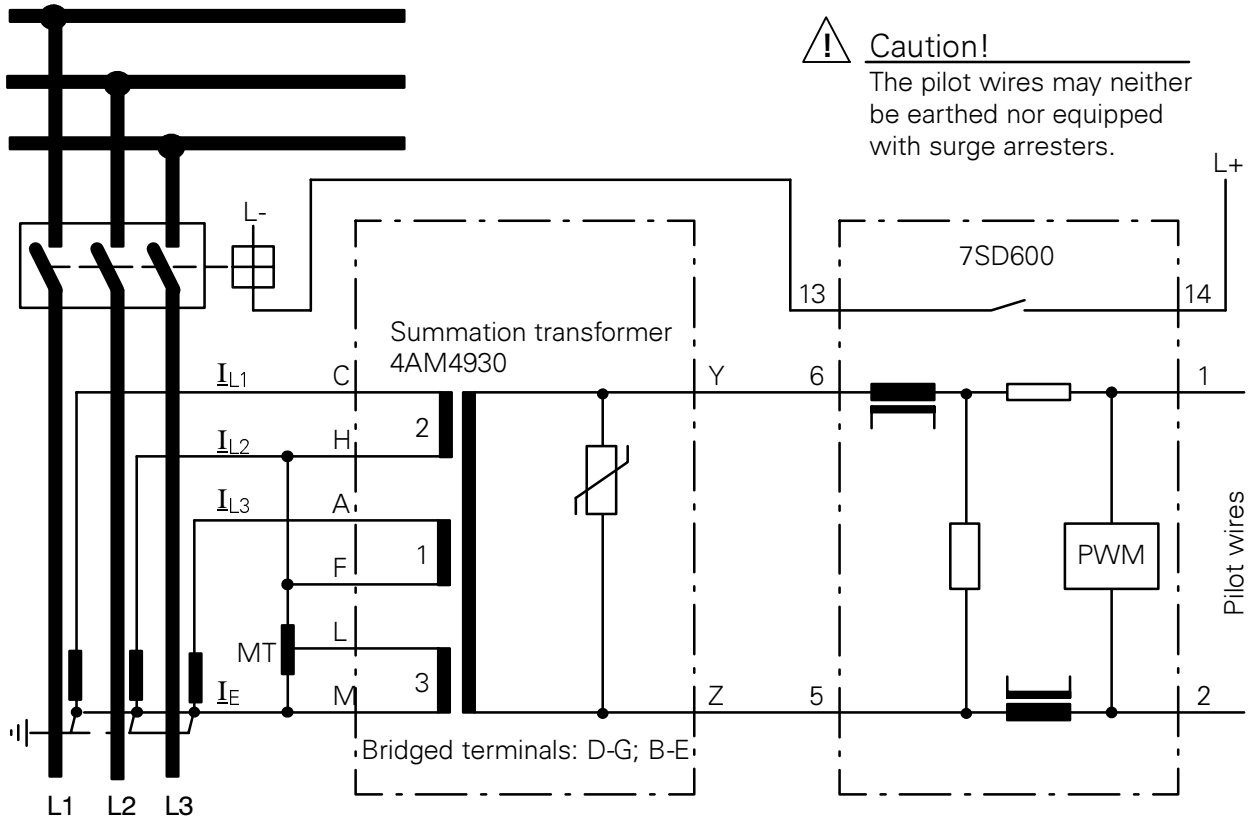

Figure A.5 Connection L1-L3-E with increased earth-fault sensitivity, preferable for low resistance earthed networks

A

Appendix

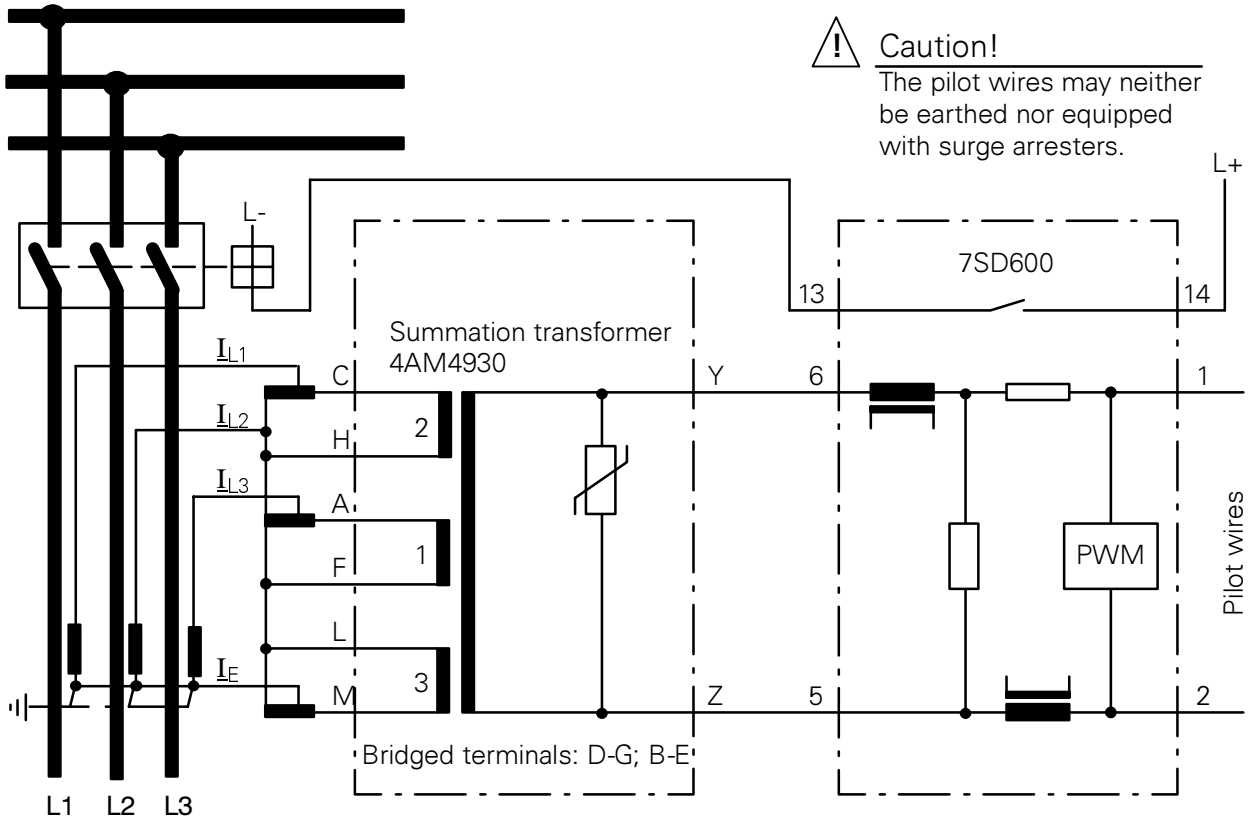

Figure A.6 Adaptation of unequal primary currents, example with standard connection L1-L3-E

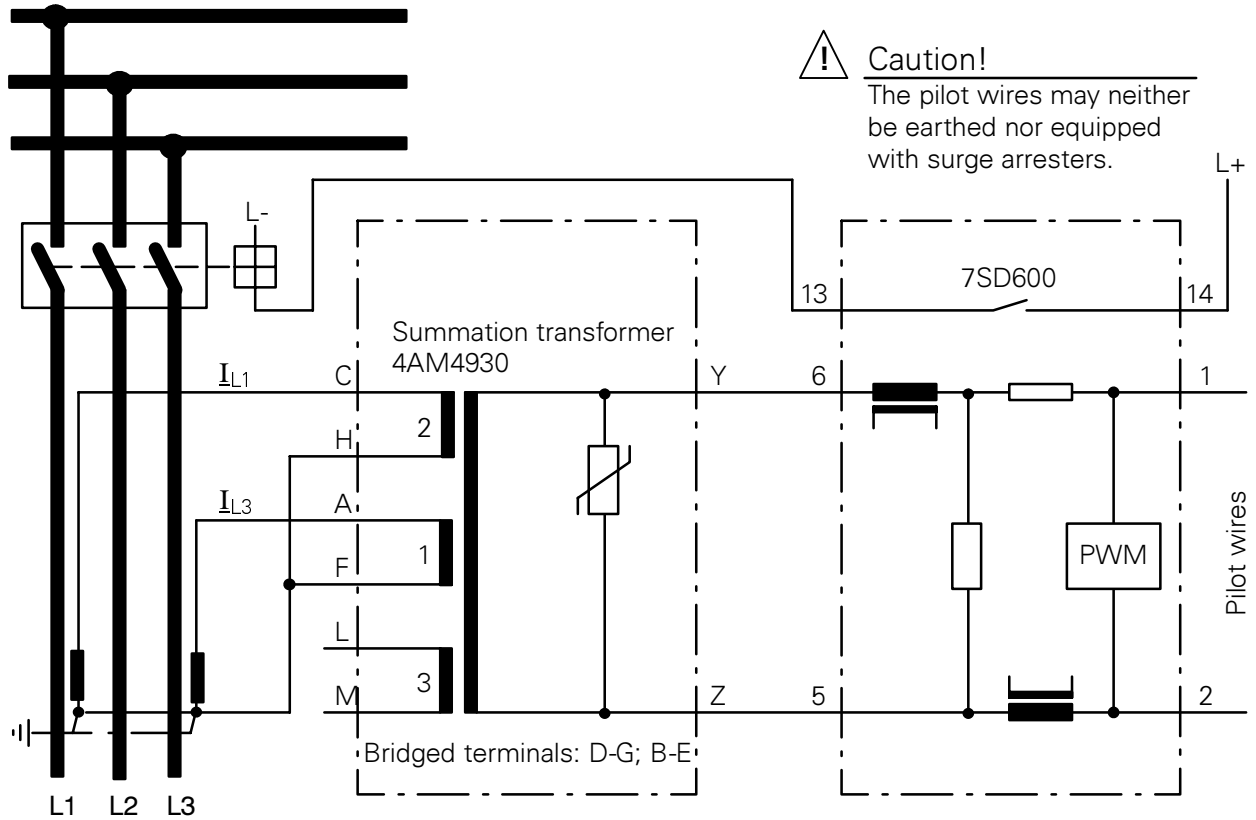

Figure A.7 Connection to two current transformers L1-L3, only for insulated or resonant-earthed networks

Caution!
The pilot wires may neither be earthed nor equipped with surge arresters.

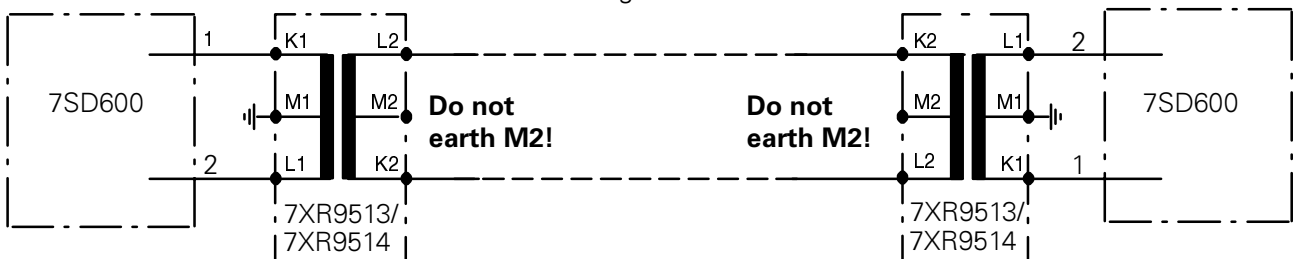
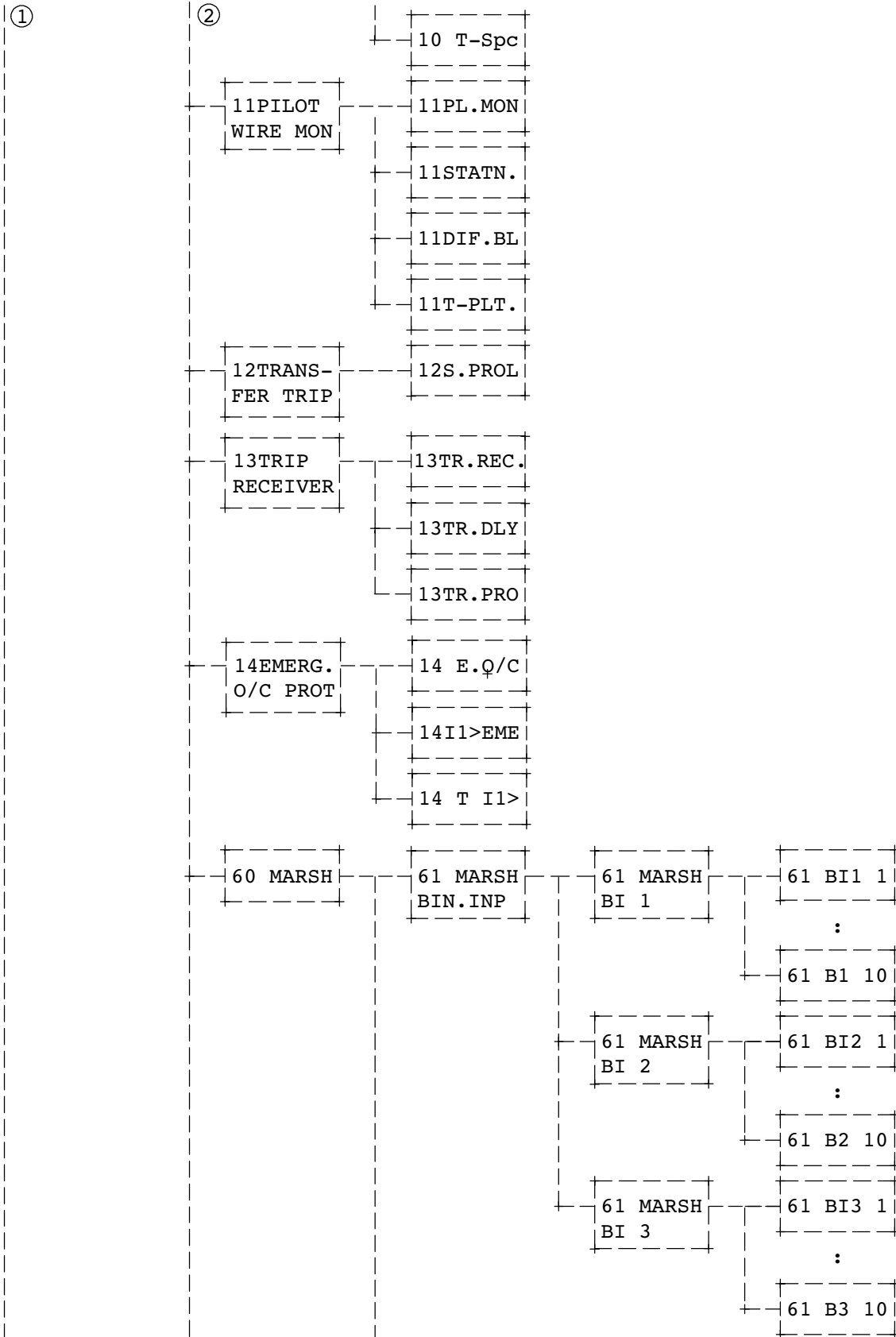

Figure A.8 Connection example for two isolating transformers 7XR9513 or 7XR9514



A

Appendix

①

②

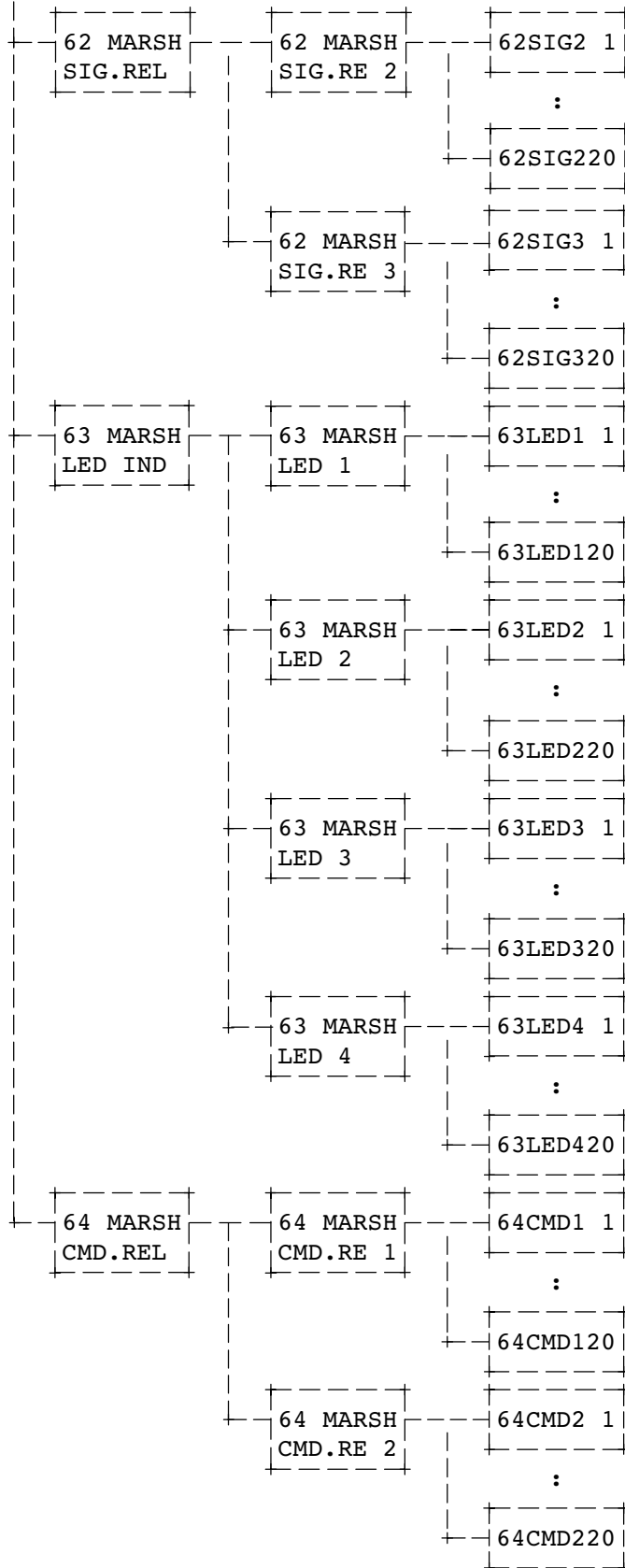

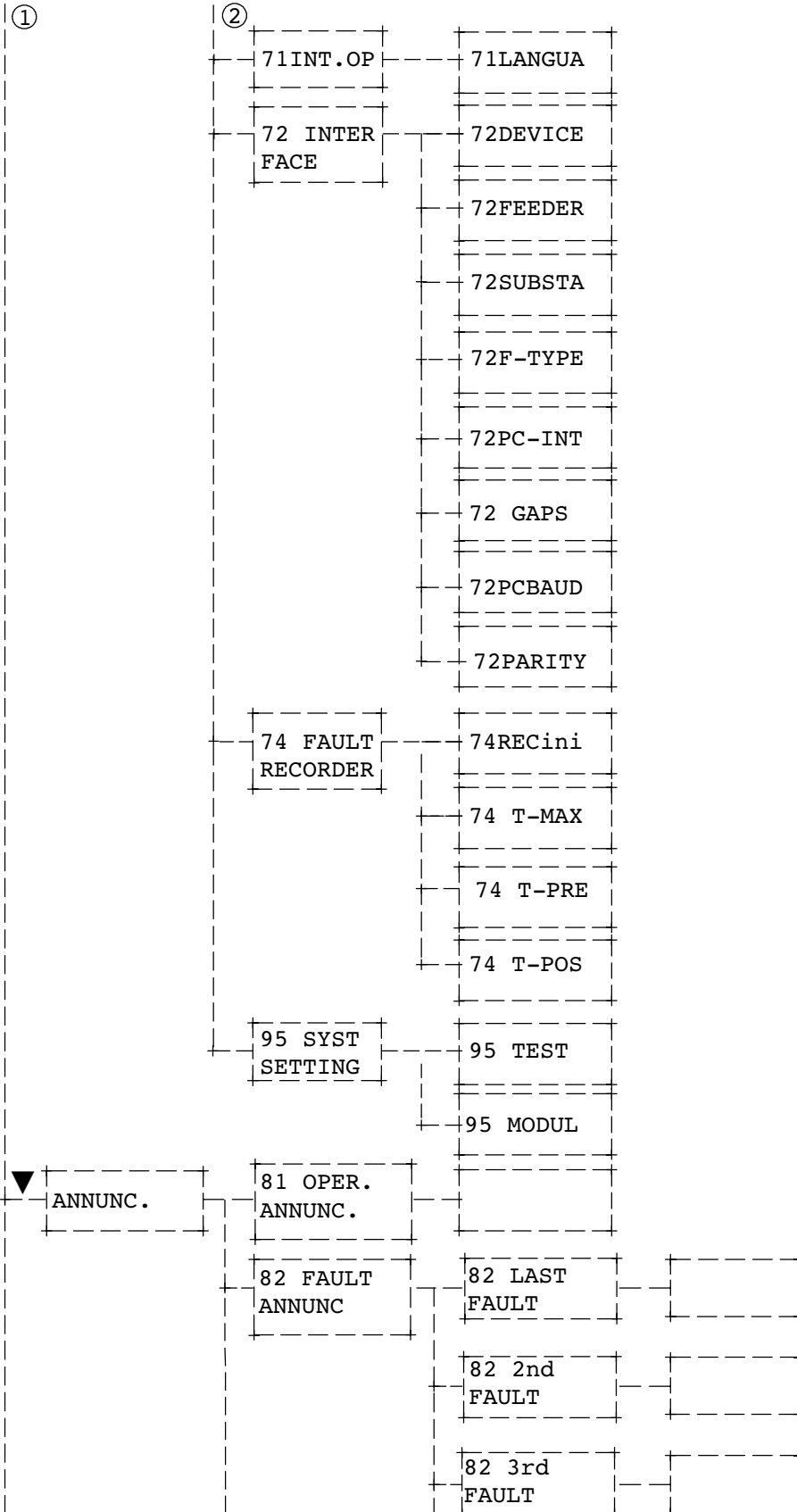

A

Appendix

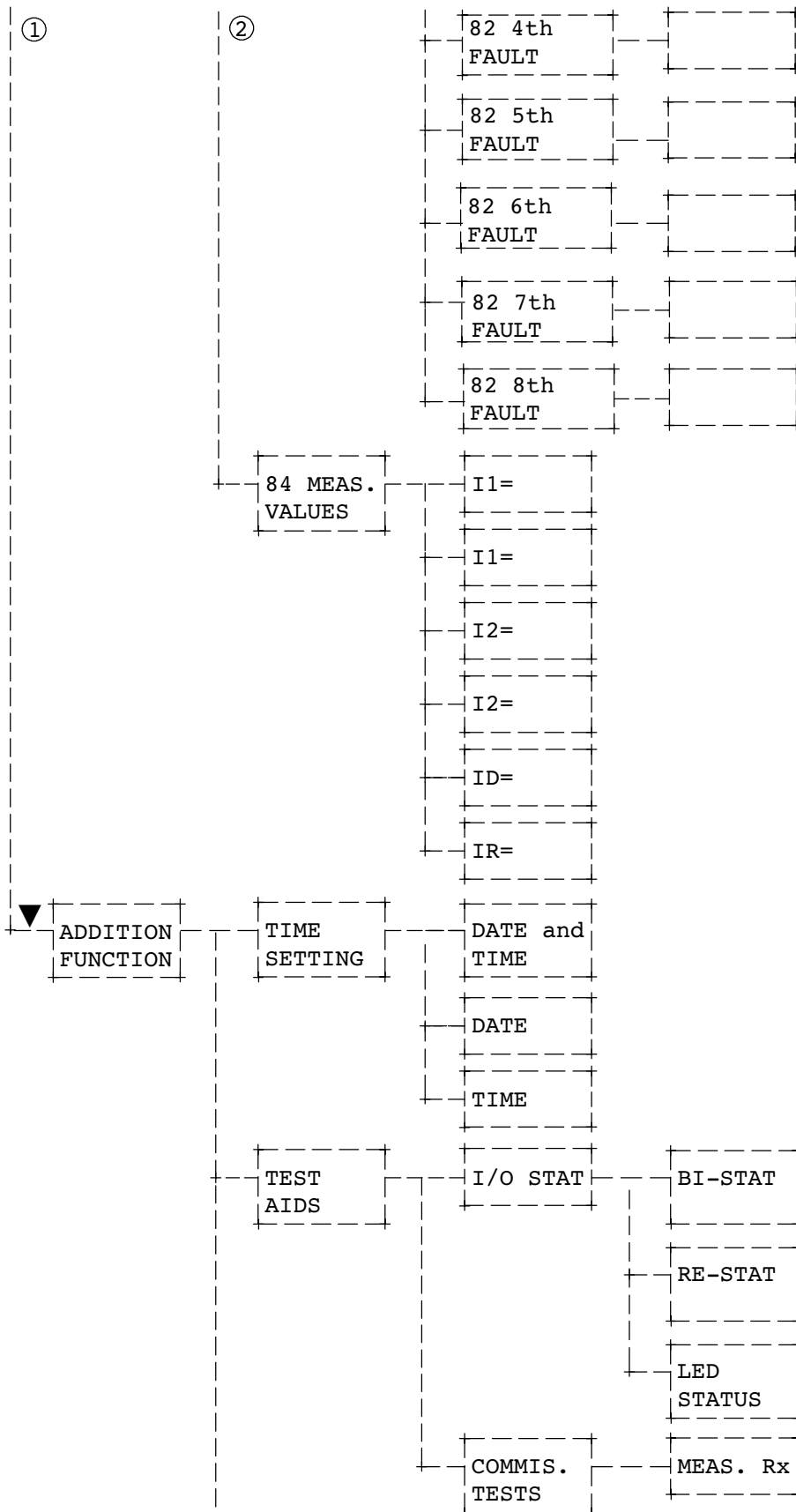

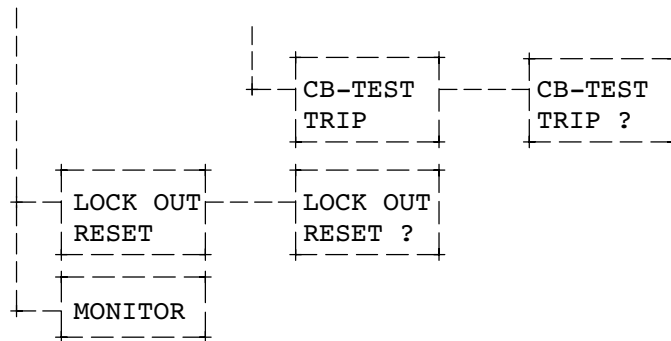

A

Appendix

Reference Table for Functional Parameters 7SD600

PARAMETER SETTINGS

00 CONF. - SCOPE OF FUNCTIONS

00 PL.MON		
nonEXIST		Pilot wire monitor
EXIST	[]	Non-existent
	[]	Existent

01 POWER SYST.DAT - POWER SYSTEM DATA

01 FREQ		Rated system frequency
50 Hz	[]	fN 50 Hz
60 Hz	[]	fN 60 Hz
01 IN LN.		Nominal current of line/cable
min. 1		A
max. 100000	----	
01 IctPRI		Primary rated current of CT
min. 1		A
max. 100000	----	
01 Rx		Pilot wire loop resistance to 2nd line end
min. 0		Ω
max. 2000	----	
01 T-TRP		Minimum trip command duration
min 0.01		s
max. 60.00	----	
01 L.Out		State of Lockout function
OFF	[]	off
ON	[]	on
01 L.O.Re		Reset of Lockout
button	[]	via LED-quit button
bin.inp.	[]	via binary input
but.o.BI	[]	via but. or bin.inp.

10 PL.WIR DIF.PROT - PILOT WIRE DIFFERENTIAL PROTECTION

10 DIF.PR		State of the differential protection
ON	[]	on
OFF	[]	off
ALRMonly	[]	Alarm only
10 IDIFF>		Pick-up value of differential current
min. 0.50		InL
max. 2.50	----	
10 I1REL.		Min. local current I1 to release trip by DIFF
min. 0.00		InL
max. 1.50	----	

10 T-DLY.		Time delay of differential protection
min. 0.00		s
max. 60.00	----	
10 HARM2		State of 2nd harmonic restraint
OFF	[]	off
ON	[]	on
10 HARM2		2nd harmonic contend in the diff. current
min. 10		%
max. 80	----	
10 IHARM2		Max. diff current for 2nd harmonic restraint
min. 1.00		InL
max. 10.00	----	
10 INT.TR		State of the intertrip send function
OFF	[]	off
ON	[]	on
10 S.PROL		Send signal prolongation for intertrip
min. 0.00		s
max. 5.00	----	
10 I-SpC		Diff current threshold for Spill Current sup.
min. 0.10		InL
max. 1.00/∞	----	
10 T-Spc		Time delay for Spill Current supervision
min. 5		s
max. 60	----	

11 PILOT WIRE MON - PILOT WIRE MONITORING

11 PL.MON		State of pilot wire monitor function
ON	[]	on
OFF	[]	off
11 STATN.		Station identification
SLAVE	[]	Slave
MASTER	[]	Master
11 DIF.BL		Block. diff. funct. during pilot wire failure
ON	[]	on
OFF	[]	off
11 T-PLT.		Time delay for blocking the diff. function
min. 0.2		s
max. 60	----	

12 TRANSFER TRIP - DIRECT REMOTE TRIP

12 S.PROL		Send signal prolongation for transfer trip
min. 0.00		s
max. 60.00	----	

A

Appendix

13 TRIP RECEIVER - TRIP RECEIVER

13 TR.REC		State of transfer trip receiver
ON	[]	on
OFF	[]	off
13 TR.DLY		Receive signal delay for transfer trip
min. 0.00		s
max. 60.00	----	
13 TR.PRO		Receive signal prol. for transf. trip
		receiver
min. 0.00		s
max. 60.00	----	

14 EMERG. O/C PROT - EMERGENCY OVERCURRENT PROTECTION

14 E.O/C		State of emergency overcurrent protection
OFF	[]	off
Flt.PWM	[]	act.w.pilot w. fail.
DIFinact	[]	act.w.dif. inactiv
14 I1>EME		Threshold I1> of emergency O/C
min. 0.10		InL
max. 15.00	----	
14 T I1>		Trip delay time of emergency O/C
min. 0.00		s
max. 60.00	----	

Reference Table for Configuration Parameters 7SD600

60 MARSH - MARSHALLING

61 MARSH BIN.INP - MARSHALLING BINARY INPUTS

61 MARSH BI 1 - MARSHALLING OF BINARY INPUT 1

61 BI1 1 BINARY INPUT 1 1st FUNCTION
-----61 BI1 2 BINARY INPUT 1 2nd FUNCTION
-----61 BI1 3 BINARY INPUT 1 3rd FUNCTION
-----61 BI1 4 BINARY INPUT 1 4th FUNCTION
-----61 BI1 5 BINARY INPUT 1 5th FUNCTION
-----61 BI1 6 BINARY INPUT 1 6th FUNCTION
-----61 BI1 7 BINARY INPUT 1 7th FUNCTION
-----61 BI1 8 BINARY INPUT 1 8th FUNCTION
-----61 BI1 9 BINARY INPUT 1 9th FUNCTION
-----61 BI1 10 BINARY INPUT 1 10th FUNCTION

61 MARSH BI 2 - MARSHALLING OF BINARY INPUT 2

61 BI2 1 BINARY INPUT 2 1st FUNCTION
-----61 BI2 2 BINARY INPUT 2 2nd FUNCTION

A

Appendix

61 BI2 3 BINARY INPUT 2 3rd FUNCTION

61 BI2 4 BINARY INPUT 2 4th FUNCTION

61 BI2 5 BINARY INPUT 2 5th FUNCTION

61 BI2 6 BINARY INPUT 2 6th FUNCTION

61 BI2 7 BINARY INPUT 2 7th FUNCTION

61 BI2 8 BINARY INPUT 2 8th FUNCTION

61 BI2 9 BINARY INPUT 2 9th FUNCTION

61 B2 10 BINARY INPUT 2 10th FUNCTION

61 MARSH BI 3 - MARSHALLING OF BINARY INPUT 3

61 BI3 1 BINARY INPUT 3 1st FUNCTION

61 BI3 2 BINARY INPUT 3 2nd FUNCTION

61 BI3 3 BINARY INPUT 3 3rd FUNCTION

61 BI3 4 BINARY INPUT 3 4th FUNCTION

61 BI3 5 BINARY INPUT 3 5th FUNCTION

61 BI3 6 BINARY INPUT 3 6th FUNCTION

61 BI3 7 BINARY INPUT 3 7th FUNCTION

61 BI3 8 BINARY INPUT 3 8th FUNCTION

61 BI3 9 BINARY INPUT 3 9th FUNCTION

61 B3 10 BINARY INPUT 3 10th FUNCTION

62 MARSH SIG.REL - MARSHALLING SIGNAL RELAYS

62 MARSH SIG.RE 2 - MARSHALLING OF SIGNAL RELAY 2

62 SIG2 1 Signal RELAY 2 1st CONDITION

62 SIG2 2 Signal RELAY 2 2nd CONDITION

62 SIG2 3 Signal RELAY 2 3rd CONDITION

62 SIG2 4 Signal RELAY 2 4th CONDITION

62 SIG2 5 Signal RELAY 2 5th CONDITION

62 SIG2 6 Signal RELAY 2 6th CONDITION

62 SIG2 7 Signal RELAY 2 7th CONDITION

62 SIG2 8 Signal RELAY 2 8th CONDITION

62 SIG2 9 Signal RELAY 2 9th CONDITION

62 SIG210 Signal RELAY 2 10th CONDITION

A

Appendix

62 SIG211 Signal RELAY 2 11th CONDITION

62 SIG212 Signal RELAY 2 12th CONDITION

62 SIG213 Signal RELAY 2 13th CONDITION

62 SIG214 Signal RELAY 2 14th CONDITION

62 SIG215 Signal RELAY 2 15th CONDITION

62 SIG216 Signal RELAY 2 16th CONDITION

62 SIG217 Signal RELAY 2 17th CONDITION

62 SIG218 Signal RELAY 2 18th CONDITION

62 SIG219 Signal RELAY 2 19th CONDITION

62 SIG220 Signal RELAY 2 20th CONDITION

62 MARSH SIG.RE 3 – MARSHALLING OF SIGNAL RELAY 3

62 SIG3 1 Signal RELAY 3 1st CONDITION

62 SIG3 2 Signal RELAY 3 2nd CONDITION

62 SIG3 3 Signal RELAY 3 3rd CONDITION

62 SIG3 4 Signal RELAY 3 4th CONDITION

62 SIG3 5 Signal RELAY 3 5th CONDITION

62 SIG3 6 Signal RELAY 3 6th CONDITION

62 SIG3 7 Signal RELAY 3 7th CONDITION

62 SIG3 8 Signal RELAY 3 8th CONDITION

62 SIG3 9 Signal RELAY 3 9th CONDITION

62 SIG310 Signal RELAY 3 10th CONDITION

62 SIG311 Signal RELAY 3 11th CONDITION

62 SIG312 Signal RELAY 3 12th CONDITION

62 SIG313 Signal RELAY 3 13th CONDITION

62 SIG314 Signal RELAY 3 14th CONDITION

62 SIG315 Signal RELAY 3 15th CONDITION

62 SIG316 Signal RELAY 3 16th CONDITION

62 SIG317 Signal RELAY 3 17th CONDITION

62 SIG318 Signal RELAY 3 18th CONDITION

62 SIG319 Signal RELAY 3 19th CONDITION

A

Appendix

62 SIG320 Signal RELAY 3 20th CONDITION

63 MARSH LED IND - MARSHALLING LED INDICATORS

63 MARSH LED 1 - MARSHALLING OF LED INDICATOR 1

63 LED1 1 LED 1 1st CONDITION

63 LED1 2 LED 1 2nd CONDITION

63 LED1 3 LED 1 3rd CONDITION

63 LED1 4 LED 1 4th CONDITION

63 LED1 5 LED 1 5th CONDITION

63 LED1 6 LED 1 6th CONDITION

63 LED1 7 LED 1 7th CONDITION

63 LED1 8 LED 1 8th CONDITION

63 LED1 9 LED 1 9th CONDITION

63 LED110 LED 1 10th CONDITION

63 LED111 LED 1 11th CONDITION

63 LED112 LED 1 12th CONDITION

63 LED113 LED 1 13th CONDITION

63 LED114 LED 1 14th CONDITION

63 LED115 LED 1 15th CONDITION

63 LED116 LED 1 16th CONDITION

63 LED117 LED 1 17th CONDITION

63 LED118 LED 1 18th CONDITION

63 LED119 LED 1 19th CONDITION

63 LED120 LED 1 20th CONDITION

63 MARSH LED 2 - MARSHALLING OF LED INDICATOR 2

63 LED2 1 LED 2 1st CONDITION

63 LED2 2 LED 2 2nd CONDITION

63 LED2 3 LED 2 3rd CONDITION

63 LED2 4 LED 2 4th CONDITION

63 LED2 5 LED 2 5th CONDITION

63 LED2 6 LED 2 6th CONDITION

63 LED2 7 LED 2 7th CONDITION

A

Appendix

63 LED2 8 LED 2 8th CONDITION

63 LED2 9 LED 2 9th CONDITION

63 LED210 LED 2 10th CONDITION

63 LED211 LED 2 11th CONDITION

63 LED212 LED 2 12th CONDITION

63 LED213 LED 2 13th CONDITION

63 LED214 LED 2 14th CONDITION

63 LED215 LED 2 15th CONDITION

63 LED216 LED 2 16th CONDITION

63 LED217 LED 2 17th CONDITION

63 LED218 LED 2 18th CONDITION

63 LED219 LED 2 19th CONDITION

63 LED220 LED 2 20th CONDITION

63 MARSH LED 3 - MARSHALLING OF LED INDICATOR 3

63 LED3 1 LED 3 1st CONDITION

63 LED3 2 LED 3 2nd CONDITION

63 LED3 3 LED 3 3rd CONDITION

63 LED3 4 LED 3 4th CONDITION

63 LED3 5 LED 3 5th CONDITION

63 LED3 6 LED 3 6th CONDITION

63 LED3 7 LED 3 7th CONDITION

63 LED3 8 LED 3 8th CONDITION

63 LED3 9 LED 3 9th CONDITION

63 LED310 LED 3 10th CONDITION

63 LED311 LED 3 11th CONDITION

63 LED312 LED 3 12th CONDITION

63 LED313 LED 3 13th CONDITION

63 LED314 LED 3 14th CONDITION

A

Appendix

63 LED315 LED 3 15th CONDITION

63 LED316 LED 3 16th CONDITION

63 LED317 LED 3 17th CONDITION

63 LED318 LED 3 18th CONDITION

63 LED319 LED 3 19th CONDITION

63 LED320 LED 3 20th CONDITION

63 MARSH LED 4 – MARSHALLING OF LED INDICATOR 4

63 LED4 1 LED 4 1st CONDITION

63 LED4 2 LED 4 2nd CONDITION

63 LED4 3 LED 4 3rd CONDITION

63 LED4 4 LED 4 4th CONDITION

63 LED4 5 LED 4 5th CONDITION

63 LED4 6 LED 4 6th CONDITION

63 LED4 7 LED 4 7th CONDITION

63 LED4 8 LED 4 8th CONDITION

63 LED4 9 LED 4 9th CONDITION

63 LED410 LED 4 10th CONDITION

63 LED411 LED 4 11th CONDITION

63 LED412 LED 4 12th CONDITION

63 LED413 LED 4 13th CONDITION

63 LED414 LED 4 14th CONDITION

63 LED415 LED 4 15th CONDITION

63 LED416 LED 4 16th CONDITION

63 LED417 LED 4 17th CONDITION

63 LED418 LED 4 18th CONDITION

63 LED419 LED 4 19th CONDITION

63 LED420 LED 4 20th CONDITION

64 MARSH CMD.REL - MARSHALLING TRIP RELAYS

64 MARSH CMD.RE 1 - MARSHALLING OF COMMAND RELAY 1

64 CMD1 1 COMMAND RELAY 1 1st CONDITION

64 CMD1 2 COMMAND RELAY 1 2nd CONDITION

A

Appendix

64 CMD1 3 COMMAND RELAY 1 3rd CONDITION

64 CMD1 4 COMMAND RELAY 1 4th CONDITION

64 CMD1 5 COMMAND RELAY 1 5th CONDITION

64 CMD1 6 COMMAND RELAY 1 6th CONDITION

64 CMD1 7 COMMAND RELAY 1 7th CONDITION

64 CMD1 8 COMMAND RELAY 1 8th CONDITION

64 CMD1 9 COMMAND RELAY 1 9th CONDITION

64 CMD110 COMMAND RELAY 1 10th CONDITION

64 CMD111 COMMAND RELAY 1 11th CONDITION

64 CMD112 COMMAND RELAY 1 12th CONDITION

64 CMD113 COMMAND RELAY 1 13th CONDITION

64 CMD114 COMMAND RELAY 1 14th CONDITION

64 CMD115 COMMAND RELAY 1 15th CONDITION

64 CMD116 COMMAND RELAY 1 16th CONDITION

64 CMD117 COMMAND RELAY 1 17th CONDITION

64 CMD118 COMMAND RELAY 1 18th CONDITION

64 CMD119 COMMAND RELAY 1 19th CONDITION

64 CMD120 COMMAND RELAY 1 20th CONDITION

64 MARSH CMD.RE 2 – MARSHALLING OF COMMAND RELAY 2

64 CMD2 1 COMMAND RELAY 2 1st CONDITION

64 CMD2 2 COMMAND RELAY 2 2nd CONDITION

64 CMD2 3 COMMAND RELAY 2 3rd CONDITION

64 CMD2 4 COMMAND RELAY 2 4th CONDITION

64 CMD2 5 COMMAND RELAY 2 5th CONDITION

64 CMD2 6 COMMAND RELAY 2 6th CONDITION

64 CMD2 7 COMMAND RELAY 2 7th CONDITION

64 CMD2 8 COMMAND RELAY 2 8th CONDITION

64 CMD2 9 COMMAND RELAY 2 9th CONDITION

64 CMD210 COMMAND RELAY 2 10th CONDITION

64 CMD211 COMMAND RELAY 2 11th CONDITION

A

Appendix

64 CMD212 COMMAND RELAY 2 12th CONDITION

64 CMD213 COMMAND RELAY 2 13th CONDITION

64 CMD214 COMMAND RELAY 2 14th CONDITION

64 CMD215 COMMAND RELAY 2 15th CONDITION

64 CMD216 COMMAND RELAY 2 16th CONDITION

64 CMD217 COMMAND RELAY 2 17th CONDITION

64 CMD218 COMMAND RELAY 2 18th CONDITION

64 CMD219 COMMAND RELAY 2 19th CONDITION

64 CMD220 COMMAND RELAY 2 20th CONDITION

71 INT.OP - INTEGRATED OPERATION

71 LANGUA		Language
ENGLISH	[]	English
DEUTSCH	[]	German
ESPANOL	[]	Spanish

72 INTER FACE - PC AND SYSTEM INTERFACES

72 DEVICE		Device address
min. 1		
max. 254	----	
72 FEEDER		Feeder address
min. 1		
max. 254	----	
72 SUBSTA		Substation address
min. 1		
max. 254	----	

72 F-TYPE		Function type in accordance with VDEW/ZVEI
min. 1		
max. 254	----	
72 PC-INT		Data format for PC-interface
DIGSI V3	[]	DIGSI V3
ASCII	[]	ASCII
VDEW-com	[]	VDEW compatible
72 GAPS		Transmission gaps for PC-interface
min. 0.0		s
max. 5.0	----	
72 PCBAUD		Transmission baud rate for PC-interface
9600BAUD	[]	9600 baud
1200BAUD	[]	1200 baud
2400BAUD	[]	2400 baud
4800BAUD	[]	4800 baud
72 PARITY		Parity and stop-bits for PC-interface
DIGSI V3		DIGSI V3
801		Odd parity,1 stopbit
8N2		No parity,2 stopbits
8N1		No parity,1 stopbit

74 FAULT RECORDER - FAULT RECORDINGS

74 RECini		Initiation of data storage
SRTwitTP		Start with trip
RECbyFT		Storage by fault det
RECbyTP		Storage by trip
74 T-MAX		Maximum time period of a fault recording
min. 0.30		s
max. 5.00	----	
74 T-PRE		Pre-trigger time for fault recording
min. 0.05		s
max. 0.50	----	
74 T-POS		Post-fault time for fault recording
min. 0.05		s
max. 0.50	----	

95 SYST SETTING - OPERATING SYSTEM SETTINGS

95 TEST		Activating internal test
NONE	[]	none
withREPO	[]	With report
BUF-OVFL	[]	Err.buf.owerfl=moni
95 MODUL		Number of tested module
min. 0		
max. 100	----	

A

Appendix

Annunciations 7SD600 for PC, LC-display and binary inputs/outputs

 FNo. - Function number of annunciation
 Op/Ft - Operation/Fault annunciation
 C/CG: Coming/Coming and Going annunciation
 M : Measurand
 I: can be marshalled to binary input
 O: can be marshalled to binary output (LED, signal/trip relay)

FNo.	Text	Meaning	Op	Ft	I	O
1	not all.	Not allocated			I	O
5	>LED r.	>Reset LED indicators			I	O
51	Dev.OK	Device operative / healthy				
52	operat.	Any protection operative	CG			O
60	LED res	LED Reset	C			
83	SigTest	For internal use only				
110	ANNlost	Annunciations lost (buffer overflow)	C			
111	PCannLT	Annunciations for PC lost	C			
113	Taglost	Fault tag lost				
115	ANNovfl	Fault annunciation buffer overflow		C		
203	REC del	Fault recording data deleted	C			
301	Sys.Flt	Fault in the power system	C	C		
302	FAULT	Flt. event w. consecutive no.	C	C		
501	FT det	General fault detection of device		CG		O
511	Dev.TRP	General trip of device		C		O
525	I1=	Interrupted current: I1		C		
605	I1=	Operat. meas. station 1 in %	M			
606	I2=	Operat. meas. station 2 in %	M			
608	ID=	Operat. meas. diff. current in %	M			
609	IR=	Operat. meas. restr. current in %	M			
655	I1=	Operat. meas. station 1 in A	M			
656	I2=	Operat. meas. station 2 in A	M			
658	ID=	Operat. meas. diff. current in A	M			
659	IR=	Operat. meas. restr. current in A	M			
1157	>CBclo	>Circuit breaker closed	CG		I	O
1174	CBtest	Circuit breaker test in progress	CG			O
1185	CBtpTST	Circuit breaker test: Trip 3pole	CG			O
2053	EME.act	Emergency O/C protection is active	CG			O
2061	EME.Flt	Emerg. O/C prot.: General fault detect.		CG		O
2141	EME.Trp	Emerg. O/C protection: General Trip		C		O
3003	>Dif.bl	>Block differential protection	CG		I	O
3008	>Res.LO	>Lockout Reset			I	O
3015	Dif.off	Differential protection is switched off	CG			O
3016	Dif.blk	Differential protection is blocked	CG			O
3017	Dif.act	Differential protection is active	CG			O
3021	Dly.st.	Diff. prot.: IDIFF> time delay started		CG		O
3022	Dif.flt	Diff. prot.: General fault detection		CG		O
3024	Block.S	Diff. prot.: Blocked by external fault		CG		O

FNo.	Text	Meaning	Op	Ft	I	O
3026	Block.H	Diff. prot.: Blocked by harmonics		CG		0
3027	Dif.TRP	Differential prot.: Trip by IDIFF>		C		0
3028	IntTrp	Diff. prot.: Intertrip send signal		CG		0
3030	B.Dif D	Diff. prot.: Blocked by IDIFF supervis.	CG			0
3031	Lockout	Trip-Lockout is in progress	CG			0
3303	>TT.blk	>Block transfer trip transmitter			I	0
3306	>Tr.TRP	>Transfer trip signal input			I	0
3312	TT.blkd	Transfer trip transmitter is blocked	CG			0
3316	TT.send	Transfer trip transmission signal	CG			0
3333	>Re.blk	>Block of trip receiver			I	0
3341	Rec.off	Trip receiver is switched off	CG			0
3342	Rec.blk	Trip receiver is blocked	CG			0
3343	Rec.act	Trip receiver is active	CG			0
3346	Rec.flt	Trip receiver: General fault detection		CG		0
3347	Rec.TRP	Trip receiver: General trip		C		0
3348	Rec.rec	Trip receiver: Trip signal received	CG			0
3363	>PWM.bl	>Block pilot wire monitor			I	0
3371	PWM.off	Pilot wire monitor is switched off	CG			0
3372	PWM.blk	Pilot wire monitor is blocked	CG			0
3376	PW.fail	Pilot wire monitor: Failure detected	CG			0

Indications of the 7SD600 for the LSA
(according to DIN 19244 / according to IEC 60870-5-103)

FNo. - function number of the event
Op/Ft - operational/fault event
K/KG: coming/coming and going event
V : event with numerical value
MV : measured value
LSA No. - number of the indication for LSA (acc. to DIN 19244) acc. to IEC60870-5-103:
CI - compatible indication
GR - indication for general request
MI - mark indication for fault value buffer
Type - function type (p: according to the parameter "function type")
Inf - information number

FNo.	Meaning	Type	LSA	IEC 60870-5-103
		Op	Ft	No. CI GR MI Type Inf
511	protection (gen.) general tripping		K	141 MI 192 161
605	operational measured value current I1 in %		MV	134 130
3376	fault in the pilot wire connection		KG	95 GR 192 76

A.5 Detailed calculation of the current transformer requirements

Both conditions 1. and 2. (see section 5.2.5) must be satisfied.

A further condition 3 may be additionally used for dimensioning the current transformers if condition 2 cannot be satisfied because the current transformers are too different.

The device can recognize an external short-circuit if the current transformers at both ends of the line transform the short circuit current without saturation for a minimum period. The device then operates with an increased stabilization and prevents overfunctioning even when the differential current temporarily ex-

ceeds the tripping value according to the stabilization characteristic. The pick-up time of the saturation detector depends on the value of the external fault current. The following table shows the relationship between the value of the fault current and the pick-up time of the detector. Since the fault current in table A.9.1 relates to the rated line current, the accuracy limiting factor must be multiplied by the ratio of transformer rated current to rated line current to obtain the pick-up time in the table. Usually this factor = 1, so that direct use of the accuracy limiting factor k' can be made.

Table A.9.1 Pick-up time of the saturation detector depending on the maximum through fault current relative to the rated line current

Fault current relative to the rated line current		2.5	4	5	7.5	10	15	20	
Pick-up time of the saturation detector t_m (ms)		12	10	9	7	5	5	5	

The accuracy limiting factor is the ratio of the maximum fault current to the rated current of the transformer. It is calculated according to condition 1 from the maximum through fault current and the transformer rated current. If this factor is multiplied by the overdimensioning factor Y , the necessary accuracy limiting factor kn' is obtained at which the saturation-free transmission time of the current transformer is reached according to table A.9.1. Factor Y considers the DC component of external short-circuits.

From the saturation-free time t_m , the CT transformer time constant t_w and the circuit frequency ω ($2 \cdot \pi \cdot f$) must be calculated using the following equation:

$$Y = 1 + \frac{\omega \cdot t_n \cdot t_w}{t_n - t_w} \left(e^{-\frac{t_m}{t_n}} - e^{-\frac{t_m}{t_w}} \right)$$

Example 1: CT. time constant $t_w = 5$ s, saturation-free time $t_m = 0.005$ s, $f = 50$ Hz $\rightarrow \omega = 314$ 1/s, system time constant $t_n = 0.1$ s. Y calculated with formula = 2.53.

3.1 Necessary operational accuracy limiting factor at line end 1 for the saturation-free time according to the table:

$$kn_1' = 2.53 \cdot I_{kd, \max} / I_{Npr}$$

3.2 Necessary operational accuracy limiting factor at line end 2 for the saturation-free time according to the table:

$$kn_2' = 2.53 \cdot I_{kd, \max} / I_{Npr}$$

The advantage is that conditions 3.1 and 3.2 are independent of the respective CT burdens. On the other hand, it leads to approx. 2-3 times higher requirements of the operational accuracy limiting factor than given by the steady-state dimensioning rules according to 1 and 2.

The operational accuracy limiting factor for the respective line end must be calculated with formula 1. The protection is stable when the operational accuracy limiting factor for line end 1 is greater than the necessary operational accuracy limiting factor kn_1' calculated with condition 3.1. The same applies for line end 2 with kn_2' .

3.3 The condition for stability is therefore:

$$n_1' > kn_1' \text{ and } n_2' > kn_2'$$

Example 2 explains the situation:

Maximum through fault current

$$I_{kd, \max} = 8000 \text{ A}$$

Line end 1:

Current transformer 10P20, 10 VA

Rated accuracy limiting factor $n_1 = 20$

Rated burden of the current transformer

$$P_N = 10 \text{ VA}$$

Internal burden of the current transformer

$$P_E = 1.5 \text{ VA}$$

Connected burden (summation transformer + connecting cable) $P_w = 4 \text{ VA}$

Primary rated current of the transformer

$$I_{Npr} = 800 \text{ A}$$

With (1) the operational accuracy limiting factor is calculated at $n_1' = 41.8$

Line end 2:

Current transformer 10P40, 20 VA

Rated accuracy limiting factor $n_2 = 40$

Rated burden of the current transformer

$$P_N = 20 \text{ VA}$$

Internal burden of the current transformer

$$P_E = 3 \text{ VA}$$

Connected burden (summation transformer + connecting cable) $P_w = 6 \text{ VA}$

Primary rated current of the transformer

$$I_{Npr} = 800 \text{ A}$$

With (1) the operational accuracy limiting factor is calculated at $n_2' = 102$

The ratio of the operational accuracy limiting factors $n_1'/n_2' = 2.4$ violates condition 2 because the current transformers are too different. Condition 1 is satisfied, i.e. the maximum steady-state fault current $k_1' = 10$ is transmitted without saturation. In the classic dimensioning, no statement could be made about the stability of the protection layout under transient conditions.

Condition 3.3 must be checked additionally to obtain a statement on the stability of the protection layout.

$$k_1' = k_2' = I_{kd, \max}/I_{Npr} = 8000 \text{ A}/800 \text{ A} = 10$$

With table A.9.1 the necessary operational accuracy limiting factor is given for the saturation-free time and 10 times the CT rated current flowing for line end 1 and line end 2. With the CT data of example 1 and the network time constant of 0.1 s the factor $Y = 2.53$:

$$kn_1' = kn_2' = 2.53 \cdot 10 = 25.3$$

The calculated operational accuracy limiting factors $n_1' = 41$ for line end 1 and $n_2' = 102$ are respectively above the necessary accuracy limit overcurrent factor so that the differential protection layout can provide stable operation despite very different current transformers during external short-circuits, because a saturation-free time of 5 ms is fulfilled on both line ends.

A

- additional functions, 4 - 16
- binary outputs, 4 - 16
- display, 4 - 16
- Disturbance recording, 4 - 17
- hardware monitoring, 4 - 17
- info display panel, 4 - 16
- info PC, 4 - 16
- measurement of operational values, 4 - 17
- monitoring functions, 4 - 17
- processing of events, 4 - 16
- software monitoring, 4 - 18
- state interrogation, 4 - 17
- Annunciations, for PC, A - 32
- Annunciations events - Block 81, 6 - 20
- Application, 1 - 1
- assembly, 5 - 2
- assembly and connection
 - cubicle mounting model , 5 - 2
 - panel flush mounting model , 5 - 2
 - panel surface mounting model , 5 - 2
- auxiliary supply voltage, 5 - 3

B

- binary inputs, 5 - 20
- binary outputs, 5 - 20
- blocking, 4 - 9

C

- CB-test function, 6 - 21
- Changing the fuse, 7 - 2
- Check switch states, binary inputs/outputs, 6 - 33
- Checking, Line differential protection, 6 - 31
- checking
 - connections, 5 - 6
 - specified ratings, 5 - 2
- Circuit-breaker trip test, 6 - 40
- Climatic Stress, 3 - 4
- command relay, 5 - 28
- Commissioning
 - general, 6 - 30
 - with primary measured signals, 6 - 33
- configuration, scope of functions, 5 - 19
- configuring, introduction, 5 - 18
- configuring the protective function, 5 - 18
- connection , 5 - 2
- connection circuit
 - reduced earth-fault sensitivity, 5 - 7
 - standard L1-L3-E, 5 - 6
- connection circuits, 5 - 6
 - increased earth-fault sensitivity, 5 - 7
 - two-phase, 5 - 8, 5 - 9
- Connection diagrams, A - 3
- Connections
 - Adaptation of unequal primary currents, A - 6
 - standard, suitable for all networks, A - 3
 - Two current transformers, A - 7
 - Two isolating transformers, A - 7

- with increased earth-fault sensitivity, A - 5
- with reduced earth-fault sensitivity, A - 4
- Control capabilities, 6 - 28
- control voltage for binary inputs, 5 - 3
- cubicle mounting, 5 - 2
- current threshold, 4 - 8
- current transformer, 5 - 9
- Current transformer requirements, Detailed calculation, A - 34
- current transformer saturation, additional stabilization, 4 - 8
- current transformer terminals, Checking the current transformer terminals, 6 - 38
- Current transformer termination, 6 - 38

D

- Date, 6 - 6
- date, 6 - 28
- demands
 - current transformer, 5 - 9
 - pilot wires, 5 - 9
- Design, 2 - 1
 - Dimensions, 2 - 2
 - Models, 2 - 1
- Detailed calculation, Current transformer requirements, A - 34
- Different primary nominal currents, 5 - 8
- differential function, 6 - 25
- Dimensions, 2 - 2
 - panel flush mounting, 2 - 4
 - panel surface mounting, 2 - 2
- Directives, 3 - 3
- Display panel, 6 - 1
- displays, 5 - 20
- disturbance recording, 4 - 17

E

- Electrical tests, 3 - 3
- electromagnetic compatibility (EMC), 3 - 5
- Emergency overcurrent function, 3 - 8, 4 - 15, 6 - 23
- emergency overcurrent protection, 6 - 41
- Events (alarms), Introduction, 6 - 18
- Events (alarms) , 6 - 18

F

- fault detection, 5 - 17
- Fault events, 6 - 23
 - Emergency overcurrent protection, 6 - 25
 - general, 6 - 24
 - Line differential protection, 6 - 25
 - other, 6 - 26
 - Remote TRIP function, 6 - 25
- Features, 1 - 2
- formation of measured values with 2 pilot wires, 4 - 6
- Front view, 6 - 3
- functional scope, 1 - 3
 - differential protection, 1 - 3
 - Emergency overcurrent protection, 1 - 3
 - other, 1 - 3
 - remote tripping, 1 - 3

I

INDEX

G

General device data, 3 - 1

H

hardware monitoring, 4 - 17

I

In rush stabilization, with 2nd harmonic, 4 - 8
Initial display, 6 - 7
Integrated operation, 5 - 14
intertrip function, 4 - 12
intertrip receiver, 6 - 25
Introduction, 1 - 1
 Application, 1 - 1

K

Keys
 Change numerical values, 6 - 1
 Change text values, 6 - 1
 Confirmation, 6 - 2
 Scrolling in the display, 6 - 2
 Yes/No, 6 - 1

L

LEDs, 5 - 26
Line differential function, 6 - 21
Line differential protection, 4 - 5, 6 - 10, 6 - 31
 Principle, 4 - 5
 Stabilized, 4 - 5
 Technical data, 3 - 6
Lockout function, 3 - 8, 6 - 22

M

Maintenance, Troubleshooting, 7 - 1
marshalling
 binary inputs, 5 - 20, 5 - 22
 binary outputs, Introduction, 5 - 20
 command relay, 5 - 28
 displays, introduction, 5 - 20
 general, 5 - 20
 LED, 5 - 26
 signal relay, 5 - 24
measured value processing, 4 - 7
Measurement, Pilot wire resistance, 6 - 36
measurement of operational values, 4 - 17
Mechanical tests, 3 - 4
Membrane keypad, 6 - 1
Memory function, 5 - 11
Menu tree, A - 8
method of operation, 4 - 1
 overall function, 4 - 1
models, 2 - 1
monitoring functions, 4 - 17

N

nominal currents, primary, 5 - 8

O

Operating conditions, 3 - 5
 General information, 5 - 11
Operating instructions, 6 - 1
Operation, 6 - 1
 Prerequisites, 6 - 2
 with PC, 6 - 2
Operational control capabilities, 6 - 28
Operational events
 CB-test function, 6 - 21
 general, 6 - 21
 Line differential protection, 6 - 21, 6 - 22, 6 - 23
Operational events - Block 81, 6 - 20
Operational measured values, Reading out, 6 - 27
Operator function, 5 - 11
Order data, 2 - 6
 accessories, 2 - 6
overall function, 4 - 1
Overview diagram, A - 1
Overview plan, A - 1

P

Packing and unpacking, 5 - 1
panel flush mounting, 2 - 4, 5 - 2
panel surface mounting, 2 - 2
Pilot wire monitoring, 4 - 11, 6 - 14
pilot wire resistance, Measuring, Setting, 6 - 36
pilot wires, 5 - 9
Preparation instructions, 5 - 1
Preparing for operation, 5 - 2
preparing for operation, assembly and connection, 5 - 2
Primary measured signals commissioning, 6 - 33
Procedure - Parameterization, 6 - 4
processing of events, 4 - 16
protective function, configuring, 5 - 18
Putting the protection into service, 6 - 43

R

Reading out operational measured values, 6 - 27
Reference Table
 for configuration parameters, A - 17
 for functional parameters, A - 14
Remote command reception, 6 - 16
Repairs, 8 - 1
Reset Lockout, 6 - 42
Routine checks, 7 - 1

S

Safety measures, 6 - 1
Selection, 2 - 6
Serial interface, 5 - 15
Setting, Pilot wire resistance, 6 - 36

- Setting
 - Memory function, 5 - 11
 - operator function, 5 - 11
- Setting date/time, 6 - 28
- Settings
 - Date/Time, 6 - 6
 - Emergency overcurrent protection, 6 - 17
 - Fault detection, 5 - 17
 - Function parameters, 6 - 4
 - Integrated operation, 5 - 14
 - Introduction, 6 - 4
 - Line differential protection, 6 - 10
 - Pilot wire monitoring, 6 - 14
 - Remote tripping, 6 - 15
 - Serial interface, 5 - 15
 - Tripping on receiving the remote command, 6 - 16
- signal relay, 5 - 24
- software monitoring, 4 - 18
- stabilization characteristic, 3 - 7
- Standards, 3 - 3
- starting, 4 - 9
- state interrogation, 4 - 17
- Station Data, 6 - 8
- Storage, 9 - 1
- Summation transformer 4AM4930, 2 - 5, 4 - 3
 - Technical data, 3 - 9
- System data, 6 - 8

T

- Tables, A - 8
- Technical data, 3 - 1
 - Additional functions, 3 - 8
 - general, 3 - 1
 - Mechanical details, 3 - 2
 - Summation transformer 4AM4930, 3 - 9
- Testing, general, 6 - 30
- the device, 5 - 1
- Time, 6 - 6, 6 - 28
- Transfer trip function, 3 - 8, 4 - 12, 6 - 22
- Transfer trip receiver, 6 - 22, 6 - 25
- Transfer tripping, 6 - 15, 6 - 41
- Trip characteristic, 6 - 11
- Trip test, with circuit-breaker, 6 - 40
- tripping logic, 4 - 9
- Troubleshooting, 7 - 2
- Troubleshooting, Maintenance, 7 - 1, 7 - 2

To
Siemens Aktiengesellschaft
PTD PA D BS
P. O. Box 4806
D - 90026 Nuremberg

Dear reader, unfortunately, it is not always possible to entirely eliminate printing errors; if, in spite of all our efforts, you should find any such errors in this manual, please notify us by returning this form. Furthermore, we always welcome any suggestions or proposals for improvement.

Sender
Name
Company/Department
Address
Phone/Fax

Suggestions	Printing	
Corrections	Order no.	Edition
7SD600 Numerical Line Differential Protection SIPROTEC 7SD600 V3.1 System manual	E50417-G1176-C069-A4	October 2002

